



TXXNTY

BRAND DESIGN

NEW NOW

2026

euroluce
— LIGHT OF ITALY —



**indice
-
index**



bubbles **95**



corallo **5**



dewy **13**



dopamine **43**



henos **65**



nido **75**

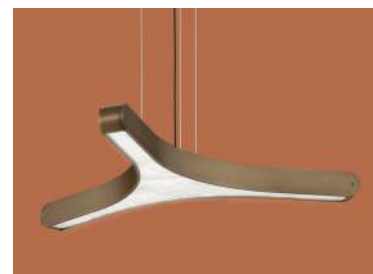

pegaso **85**



theorem **55**



trama **111**



corallo

*Nella forma ricorda le isole coralline.
La lucentezza del cristallo, richiama lo scintillio delle acque
scaldate dalla luce del sole.*

STUDIO IN PROJECT

*The shape is reminiscent of coral islands.
The sheen of the crystal, recalls the sparkle of the water
warmed by sunlight.*

STUDIO IN PROJECT

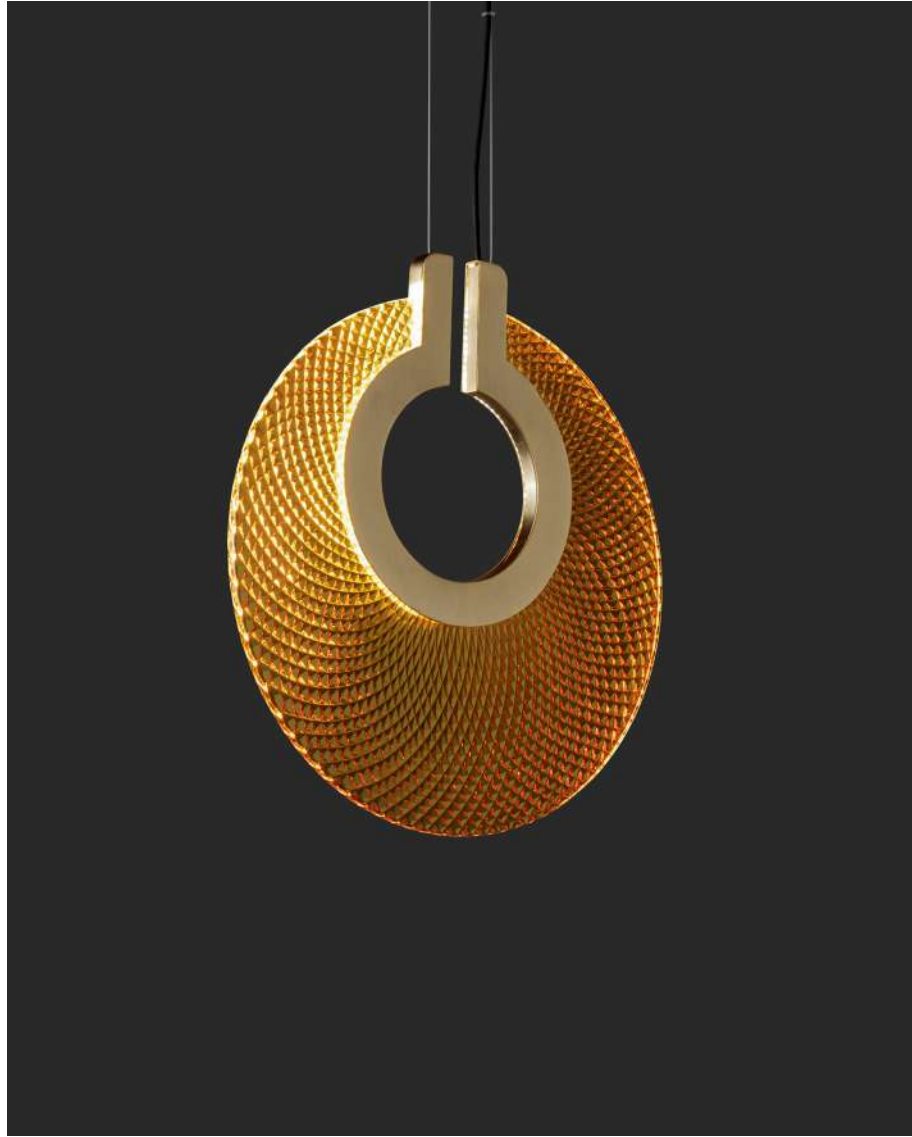

Scan to discover the entire **CORALLO** collection



Corallo Project S18 - The most successful collection of the 2025 Salone Del Mobile, Milan





Corallo Project S9

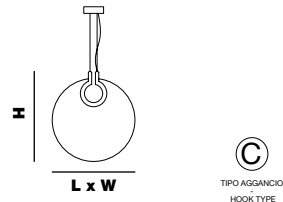

CORALLO 50

L x W 50 x 2 cm | 19,69" x 0,79"
H 56 cm | 22,05"

striped 7,1W - 3000°K - 24 Vdc - SMD 2835
660 lm - life time 50.000 hrs - Dimmable: on demand -
Energy Efficiency: A++ - VOL: 0,108 m³ - 4 kg

Metal box Ø: 150 mm | **5,90" H:** 30 mm | 1,81"

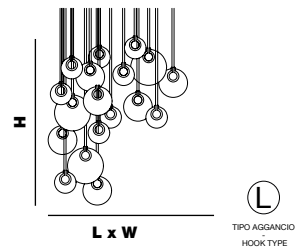

CORALLO S18

L x W 200 x 40 cm | 86,61" x 15,78"
H 235 cm | 37,40"

striped 128W - 3000°K - 24 Vdc - SMD 2835
11880 lm - life time 50.000 hrs - Dimmable: on demand -
Energy Efficiency: A++ - VOL: 0,392 m³ - 45 kg

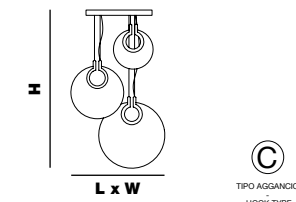

CORALLO S3

L x W 80 x 20 cm | 31,50" x 7,87"
H 100 cm | 39,37"

striped 21,3W - 3000°K - 24 Vdc - SMD 2835
1980 lm - life time 50.000 hrs - Dimmable: on demand -
Energy Efficiency: A++ - VOL: 0,216 m³ - 9,5 kg

Metal box LxW: 500 mm x 200 mm | 7,87" x 5,90"
H: 50 mm | 1,96"

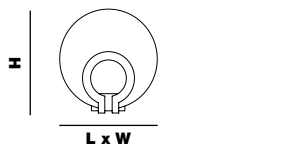

CORALLO wall lamp

L x W 30 x 16 cm | 18,11" x 6,30"
H 30 cm | 18,11"

striped 7,1W - 3000°K - 24 Vdc - SMD 2835
660 lm - life time 50.000 hrs - Dimmable: on demand -
Energy Efficiency: A++ VOL: 0,0608 m³ - 2 kg

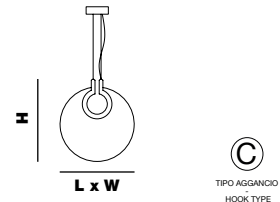

CORALLO 40

L x W 40 x 2 cm | 15,75" x 0,79"
H 46 cm | 18,11"

striped 7,1W - 3000°K - 24 Vdc - SMD 2835
660 lm - life time 50.000 hrs - Dimmable: on demand -
Energy Efficiency: A++ - VOL: 0,0691 m³ - 2,5 kg

Metal box Ø: 150 mm | **5,90" H:** 30 mm | 1,81"

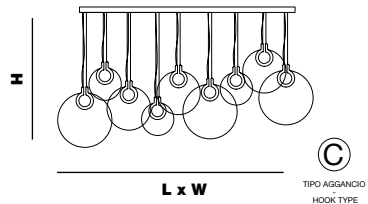

CORALLO S9

L x W 220 x 40 cm | 86,61" x 15,78"
H 95 cm | 37,40"

striped 65W - 3000°K - 24 Vdc - SMD 2835
5940 lm - life time 50.000 hrs - Dimmable: on demand -
Energy Efficiency: A++ - VOL: 0,6 m³ - 30 kg

Metal box LxW: 2000 mm x 400 mm | 78,74 x 15,74"
H: 50 mm | 1,96"

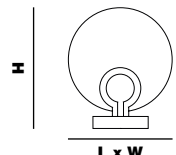

CORALLO big lamp

L x W 40 x 8 cm | 15,75" x 3,15"
H 45 cm | 17,52"

strip-led 7,1W - 3000°K - 24 Vdc - SMD 2835
660 lm - life time 50.000 hrs - Dimmable: on demand -
Energy Efficiency: A++ - VOL: 0,105 m³ - 4 kg

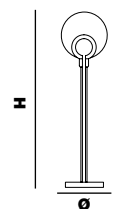

CORALLO floor lamp

Ø 30 cm | 18,11"
H 150 cm | 59,05"

strip-led 7,1W - 3000°K - 24 Vdc - SMD 2835
660 lm - life time 50.000 hrs - Dimmable: on demand -
Energy Efficiency: A++ - VOL: 0,3949 m³ - 2 kg

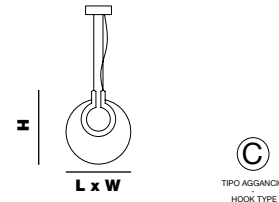

CORALLO 30

L x W 30 x 2 cm | 11,81" x 0,79"
H 36 cm | 14,17"

striped 7,1W - 3000°K - 24 Vdc - SMD 2835
660 lm - life time 50.000 hrs - Dimmable: on demand -
Energy Efficiency: A++ - VOL: 0,0608 m³ - 2 kg

Metal box Ø: 150 mm | **5,90" H:** 30 mm | 1,81"

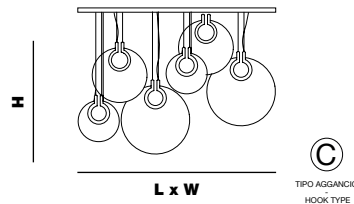

CORALLO S6

L x W 120 x 25 cm | 47,24" x 9,84"
H 95 cm | 37,40"

striped 42,6W - 3000°K - 24 Vdc - SMD 2835
3960 lm - life time 50.000 hrs - Dimmable: on demand -
Energy Efficiency: A++ - VOL: 0,243 m³ - 20kg

Metal box LxW: 1200 mm x 250 mm | 47,24 x 9,84"
H: 50 mm | 1,96"



CORALLO small lamp

L x W 30 x 7 cm | 11,81" x 2,76"
H 34 cm | 13,19"

striped 7,1W - 3000°K - 24 Vdc - SMD 2835
660 lm - life time 50.000 hrs - Dimmable: on demand -
Energy Efficiency: A++ - VOL: 0,0608 m³ - 2,2 kg

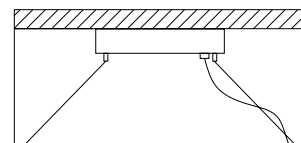

Altezza - Height
MIN 24 cm - 9,44"

C Aggancio con rosone o scatola e tiranti per sospensioni. Altezza regolabile (C)
Hook with ceiling cup or metal box and metal cables for suspension. Adjustable height (C)

L Aggancio da definire (L)
Hooks to be defined (L)

corallo

Studio in Project

Particolari - Details

Strutture realizzate artigianalmente. Dischi in vetro con effetto diamantato molati a mano.
Per qualsiasi richiesta o differente versione non esitate a contattarci.

Handcrafted structures. Glass disks with hand ground diamond effect.
For any request or different version please contact us.

Metalli - Metals

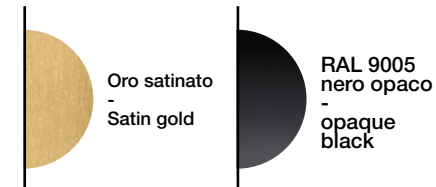

Vetro - Glass



Trasparente
Transparent

Rosaline

Acquamarine
Aquamarine

Viridian

Fumè grigio
Fumè grey

Ambra
Amber



Guarda il video

Watch video

* Specifiche agganci - Info on hooks pag. 134 - 135 *

* Altre finiture e colori su richiesta - Other finishes and colors on request - see pag. 136 - 137 *

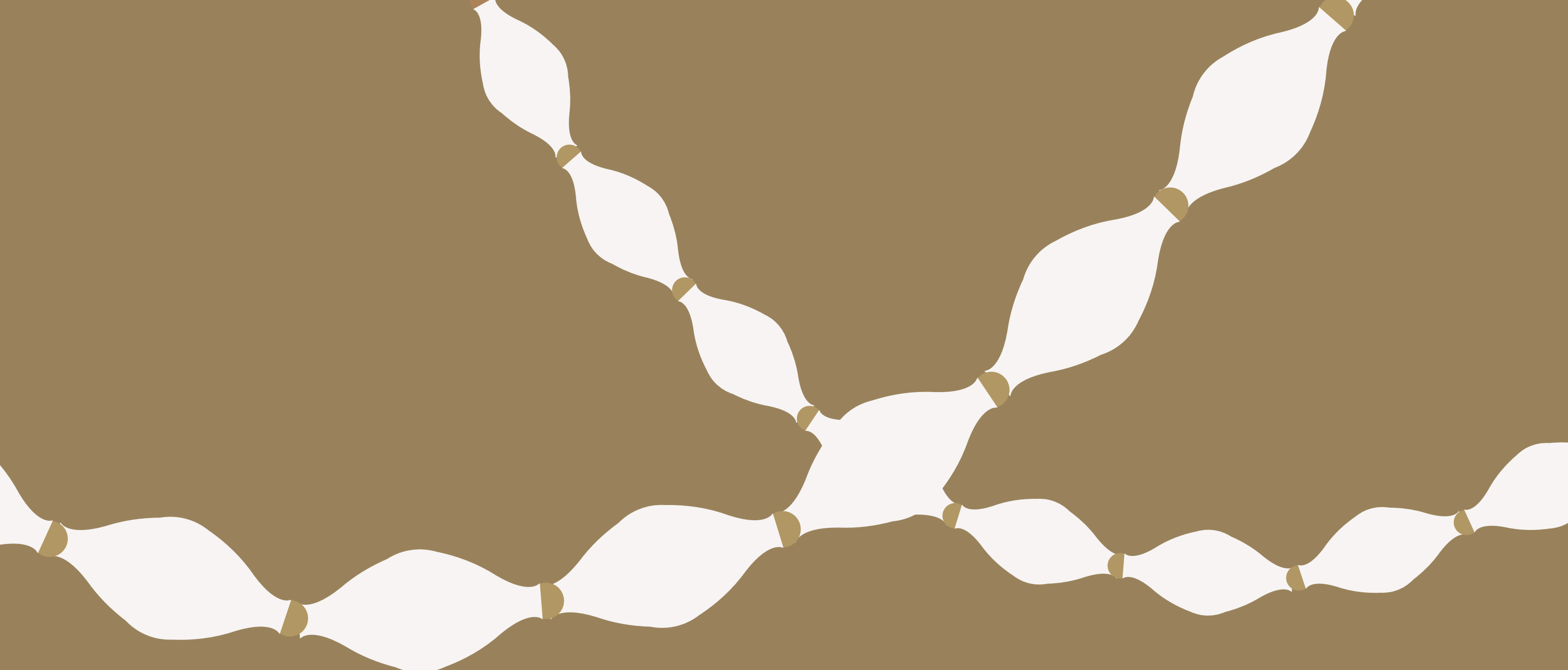

dewy

In una fresca mattinata primaverile un lungo filo d'erba si arcua dolcemente, gravido di regolari goccioline di rugiada che rifrangono la calda e tenue luce solare del primo mattino.

ALBERTO GHIRARDELLO

On spring morning, a long blade of grass arches gently, pregnant with regular dewdrops that refract the warm, soft early morning sunlight.

ALBERTO GHIRARDELLO





Dewy Project S3 + S4 + S4





Dewy Project S7 + S12



Dewy Project S7 + S12





Dewy Project S4 x 5



Dewy project S4 Horizontal x 2







satin fumè



satin viridian



satin rosaline



satin tobacco



Dewy S7 Satin Tobacco



Dewy S7 Satin Viridian

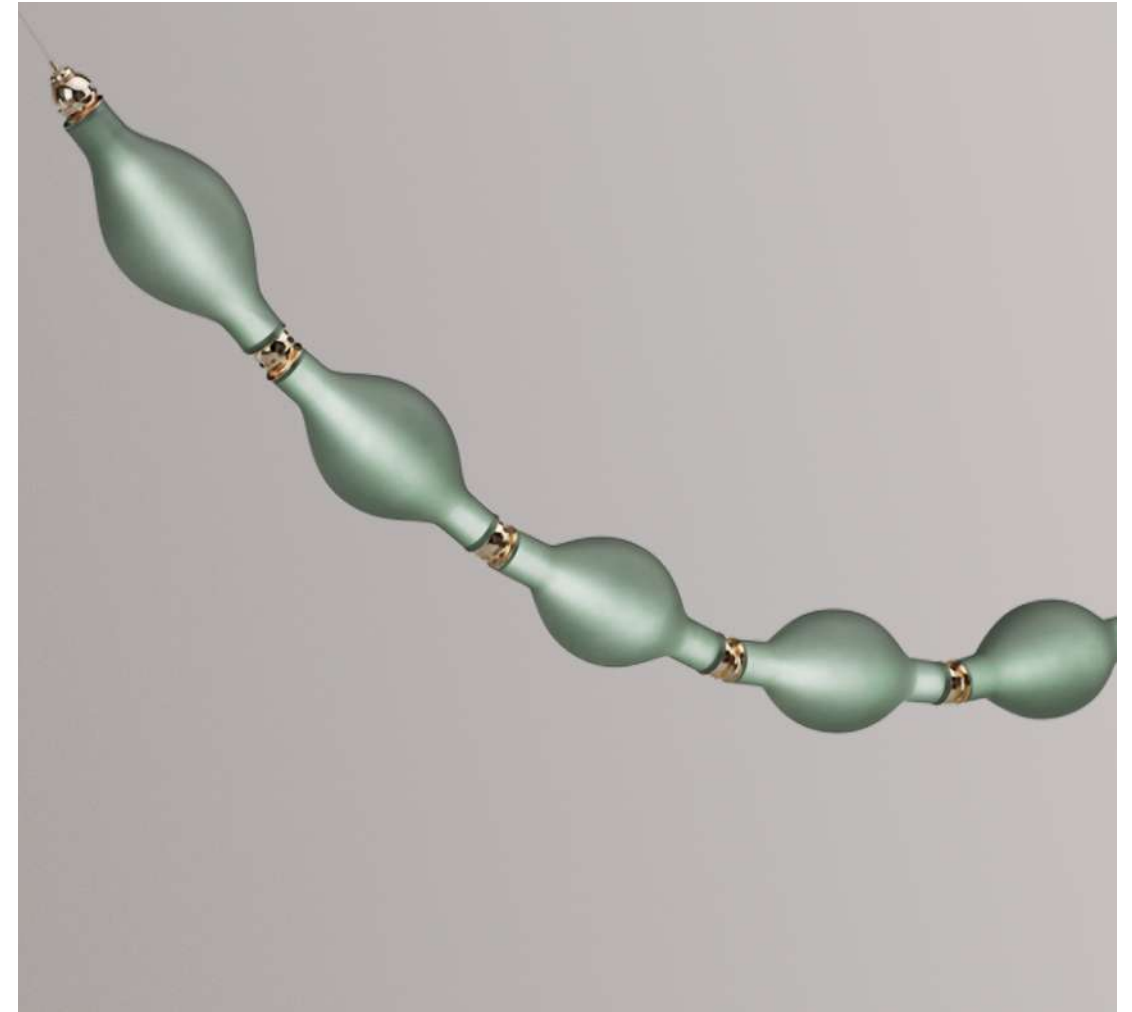



Transparent fumè



Transparent Viridian

Dewy Project S7+ S7





Dewy PT9 special project X9



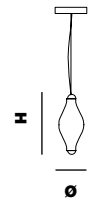

FIXED



DEWY S1

Ø 12 cm | 4,72"
H 30 cm | 11,81"

1 - 360° neon flex 4,32W - 3000°K - 24 Vdc - 240 lm - Dimmable: on demand - Energy Efficiency: A++ - VOL: 0,0608 m³ - 1 kg

Metal box Ø: 120 mm | 4,72"
H: 30 mm | 1,18"

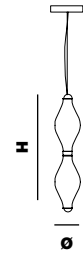

FIXED



DEWY S2

Ø 12 cm | 4,72"
H 67 cm | 26,37"

1 - 360° neon flex 10 W - 3000°K - 24 Vdc - 536 lm - Dimmable: on demand - Energy Efficiency: A++ - VOL: 0,1125 m³ - 1,1 kg

Metal box Ø: 150 mm | 5,90"
H: 30 mm | 1,18"

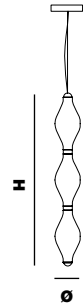

FIXED



DEWY S3

Ø 12 cm | 4,72"
H 97 cm | 38,18"

1 - 360° neon flex 14,4 W - 3000°K - 24 Vdc - 776 lm - Dimmable: on demand - Energy Efficiency: A++ - VOL: 0,3 m³ - 1,5 kg

Metal box Ø: 150 mm | 5,90"
H: 30 mm | 1,18"

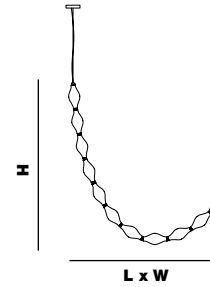

MOULDBLE



DEWY S11

LxW 165 x 12 cm | 64,96" x 4,72"
H 170 cm | 66,92"
total length 350 cm | 137,80"

1 - 360° neon flex 51 W - 3000°K - 24 Vdc - 2800 lm - Dimmable: on demand - Energy Efficiency: A++ - VOL: 0,576 m³ - 8 kg

Metal box Ø: 200 mm | 7,87"
H: 40 mm | 1,57"

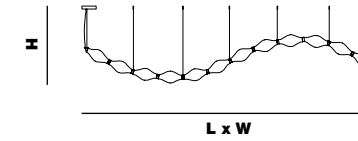

MOULDBLE



DEWY S12

LxW 315 x 12 cm | 124,02" x 4,72"
H 45 cm | 17,72"
total length 367 cm | 144,48"

1 - 360° neon flex 53W -3000°K - 24 Vdc - 2936 lm - Dimmable: on demand - Energy Efficiency: A++ - VOL: 0,576 m³ - 9,5 kg

Metal box Ø: 200 mm | 7,87"
H: 40 mm | 1,57"

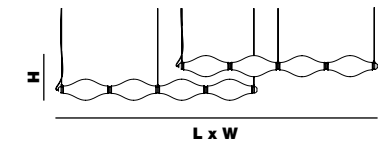

FIXED



DEWY S4 HORIZONTAL X2

LxW 180 x 25 cm | 70,87" x 9,84"
H 25 cm | 9,84"

2 - 360° neon flex 34,6W -3000°K - 24 Vdc - 1920 lm - Dimmable: on demand - Energy Efficiency: A++ - VOL: 0,3 m³ - 4,4 kg

Customisable configuration

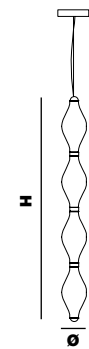

FIXED



DEWY S4 VERTICAL

Ø 12 cm | 4,72"
H 120 cm | 47,24"

1 - 360° neon flex 17,30 W - 3000°K - 24 Vdc - 960 lm - Dimmable: on demand - Energy Efficiency: A++ - VOL: 0,3 m³ - 2,2 kg

Metal box Ø: 200 mm | 7,87"
H: 30 mm | 1,18"

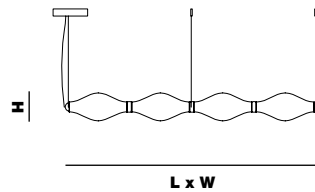

FIXED



DEWY S4 HORIZONTAL

LxW 120 x 12 cm | 47,24" x 4,72"
H 12 cm | 4,72"

1 - 360° neon flex 17,30W -3000°K - 24 Vdc - 960 lm - Dimmable: on demand - Energy Efficiency: A++ - VOL: 0,3 m³ - 2,2 kg

Metal box Ø: 200 mm | 7,87"
H: 40 mm | 1,57"

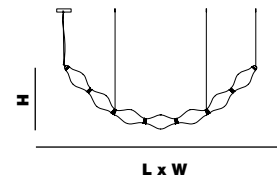

MOULDBLE



DEWY S7

LxW 165 x 12 cm | 64,96" x 4,72"
H 55 cm | 21,65"
total length 217 cm | 85,43"

1 - 360° neon flex 32 W - 3000°K - 24 Vdc - 1736 lm - Dimmable: on demand - Energy Efficiency: A++ - VOL: 0,324 m³ - 4 kg

Metal box Ø: 200 mm | 7,87"
H: 40 mm | 1,57"

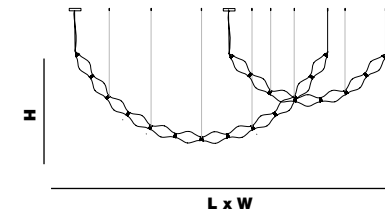

DEWY S12+S7

LxW 315 x 35 cm | 124" x 13,77"
H 90 cm | 35,43"

2 - 360° neon flex 85 W - 3000°K - 24 Vdc - 4672 lm - Dimmable: on demand - Energy Efficiency: A++ VOL: 1,008 m³ - 13,5 kg

Customisable configuration

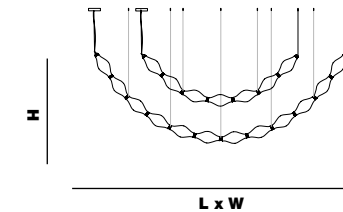

DEWY S12+S7

LxW 260 x 35 cm | 102,36" x 13,77"
H 90 cm | 35,43"

2 - 360° neon flex 85 W - 3000°K - 24 Vdc - 4672 lm - Dimmable: on demand - Energy Efficiency: A++ VOL: 1,008 m³ - 13,5 kg

Customisable configuration

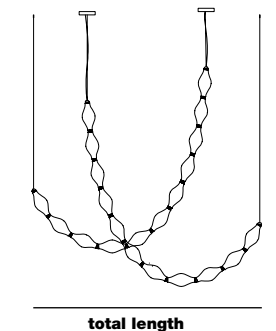

DEWY S11+S11

LxW 160 x 135 cm | 62,99" x 53,14"
H 200 cm | 78,74"

2 - 360° neon flex 102 W - 3000°K - 24 Vdc - 5600 lm - Dimmable: on demand - Energy Efficiency: A++ - VOL: 0,576 m³ - 16 kg

Customisable configuration

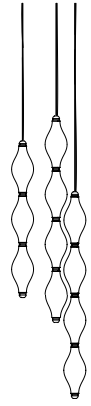

DEWY S3+S4+S4

Ø 40 cm | 15,75"
H 150 cm | 59,06"

3 - 360° neon flex 48,6 W - 3000°K - 24 Vdc - 2696 lm - Dimmable: on demand - Energy Efficiency: A++ - VOL: 0,3 m³ - 5,9 kg

Customisable configuration

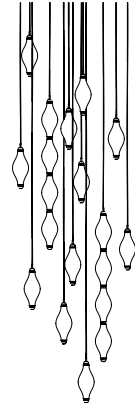

DEWY S19

Ø 90 cm | 35,43"
H 280 cm | 110,24"

360° neon flex 83 W - 3000°K - 24 Vdc - 4560 lm - Dimmable: on demand - Energy Efficiency: A++ - VOL: 1,008 m³ - 15,5 kg

Customisable configuration

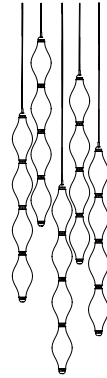

DEWY S4x5

Ø 75 cm | 29,5"
H 200 cm | 78,74"

5 - 360° neon flex 85,6 W - 3000°K - 24 Vdc - 4800 lm - Dimmable: on demand - Energy Efficiency: A++ - VOL: 0,3 m³ - 11 kg

Customisable configuration

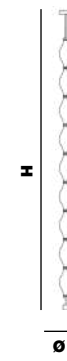

DEWY PT9 SPECIAL

Ø 12 cm | 4,72"
H 284 cm | 111,81"

1 - 360° neon flex 36 W - 3000°K - 24 Vdc - 2008 lm - Dimmable: on demand - Energy Efficiency: A++ VOL: 1,008 m³ - 6 kg

Ceiling Metal box: Ø200 mm | 7,87"
H: 30 mm | 1,18"

Floor Metal box: Ø60mm | 2,37"
H: 60mm | 2,37"

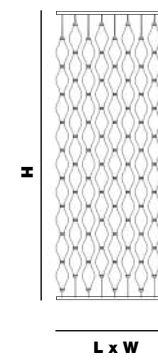

DEWY PT9 SPECIAL PROJECT X9

LxW 114 x 12 cm | 44,84" x 4,72"
H 284 cm | 111,81"

9 - 360° neon flex 324 W - 3000°K - 24 Vdc - 18072 lm - Dimmable: on demand - Energy Efficiency: A++ VOL: 5,184 m³ - 54 kg

Ceiling Metal box: **LxW** 1140 x 120 mm | 44,88" x 4,72"
H: 60mm | 2,37"

Floor Metal box: **LxW** 1140 x 120mm | 44,88" x 4,72"
H: 60mm | 2,37"

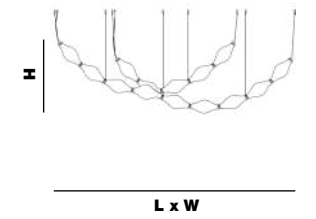

DEWY S7+S7

LxW 223 x 80 cm | 87,80" x 31,50"
H 94 cm | 37,01"

2 - 360° neon flex 64 W - 3000°K - 24 Vdc - 3472 lm - Dimmable: on demand - Energy Efficiency: A++ VOL: 0,576 m³ - 8 kg

Customisable configuration

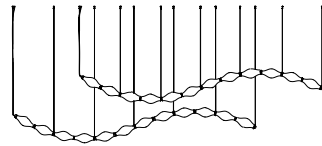

total length



MOULDABLE

DEWY S12+S12

LxW 400 x 45 cm | 157,48" x 17,71"
H 95 cm | 37,40"

2 - 360° neon flex 106 W - 3000°K - 24 Vdc - 5872 lm - Dimmable: on demand - Energy Efficiency: A++ VOL: 1,008 m³ - 19 kg

Customisable configuration



Aggancio con tirante in metallo (A)
Hook with metal cable (A)

L'altezza dei lampadari è calcolata escludendo l'aggancio. Aggancio con rosone o scatola e filo tirante.
The height of the chandeliers is calculated by excluding the hook. Hook with the ceiling cup or metal box and cable

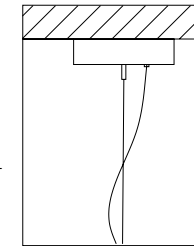

Altezza - Height
MIN 18 cm - 7,08"



Aggancio con tiranti e tasselli a soffitto (F)
- Hook with metal cables and ceiling cable gripper (F)

L'altezza delle sospensioni è calcolata escludendo l'aggancio. Aggancio con rosone e tiranti con tasselli a soffitto.
The height of suspensions is calculated by excluding the hook. Hook with the ceiling cup and metal cables with ceiling cable gripper.

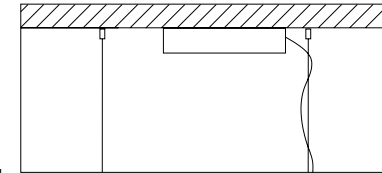

Altezza - Height
MIN 24 cm - 9,44"



Aggancio da definire (L) - Hooks to be defined (L)

*L'altezza dei lampadari e il relativo prezzo è calcolata escludendo l'aggancio. Per le proposte progettuali è possibile richiedere Aggancio L1: scatola in metallo H MIN 5 cm o in legno H MIN 10 cm, decorati o successivamente verniciabili da ancorare al soffitto con staffa. Aggancio L2: senza scatola; gli elementi prevedono agganci singoli a soffitto. Si richiede la presenza di soffitto in cartongesso. *The height of the chandeliers and their price is calculated excluding the hook. For project proposals it is possible to request Hook L1: metal box H MIN 5 cm or wood H MIN 10 cm, decorated or subsequently paintable to be anchored to the ceiling with bracket. Hook L2: without box; the elements provide individual ceiling hooks. It requires the presence of plasterboard ceiling.

*** per informazioni specifiche riferirsi alle sezioni relative ai singoli prodotti.**
*** for specific information refer to individual product sections.**

Finiture metalli - Metal Finishes

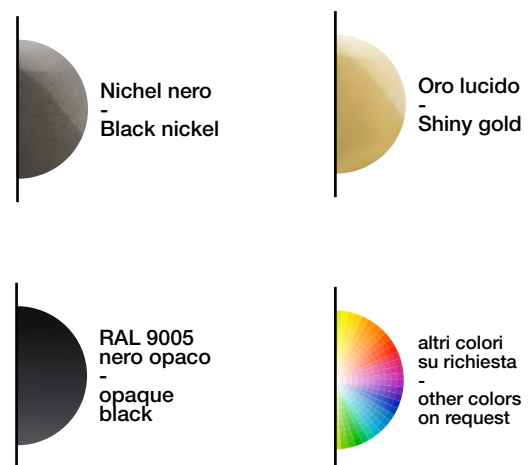

Finiture vetri - Glass Finishes

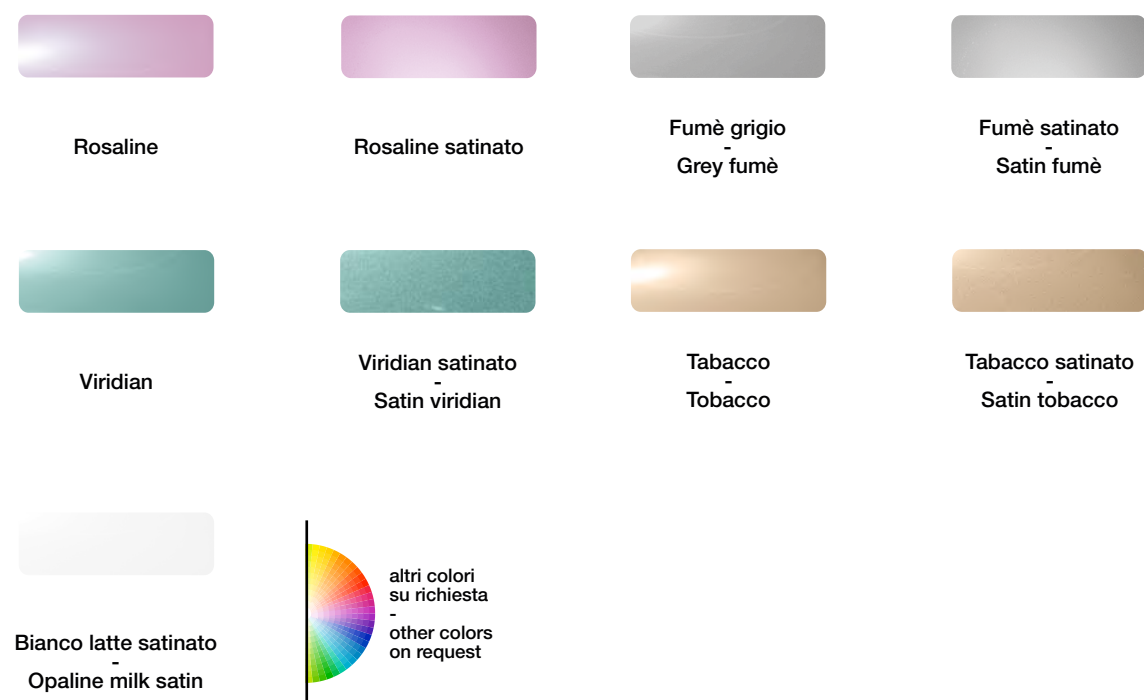

Dewy

Alberto Ghirardello

Particolari - Details

Collezione modulare e personalizzabile nelle lunghezze, con vetri in borosilicato decorati per una luce armoniosa. Boccole in alluminio tornito permettono flessibilità e adattabilità nelle forme. All'interno un neonflex 360° percorre l'intera collana senza interruzioni di luce. Possibilità di scegliere 3000 k / 4000 k

Modular collection, customisable in lengths, with decorated borosilicate glass for harmonious light. Turned aluminium bushings allow flexibility and adaptability in shapes. Inside, a 360° neonflex runs through the entire necklace without interruption of light. Choice of 3000 k / 4000 k

NB: DEWY è DISPONIBILE NELLA VERSIONE FIXED E NELLA VERSIONE MOLDABLE.

FIXED VERSION: con anima interna che rende la composizione perfettamente lineare.

Possibile lineare orizzontale e lineare verticale. Il modulo proposto è di max n.4 elementi con possibilità di affiancare altri moduli per composizioni project.

MOULDABLE VERSION: Senza anima interna, la composizione può creare forme morbide nello spazio.

Sono forniti i terminali e un kit di agganci singoli per modellare la composizione autonomamente. Ciascuna Dewy potrà essere composta da max 16 elementi.

La dimensione indicata è la lunghezza totale della composizione. La conformazione del disegno è puramente indicativa.

* Per qualsiasi richiesta o differente versione non esitate a contattarci.

NB: DEWY IS AVAILABLE IN THE FIXED VERSION AND IN THE MOLDABLE VERSION.

FIXED VERSION: with an internal core that makes the composition perfectly linear.

Horizontal linear and vertical linear possible. The proposed module is a maximum of n.4 elements with the possibility of adding others for project compositions.

MOULDABLE VERSION: Without an internal core, the composition can create soft shapes in space.

End pieces and a kit of individual hooks are provided to shape the composition independently. Each Dewy can be composed of up to 16 elements.

The size indicated is the total length of the composition. The shape of the drawing is purely indicative.

* Please do not hesitate to contact us for any requests or different versions.

* Specifiche agganci - Info on hooks pag. 134 - 135 *

* Altre finiture e colori su richiesta - Other finishes and colors on request - see pag. 136 -137 *

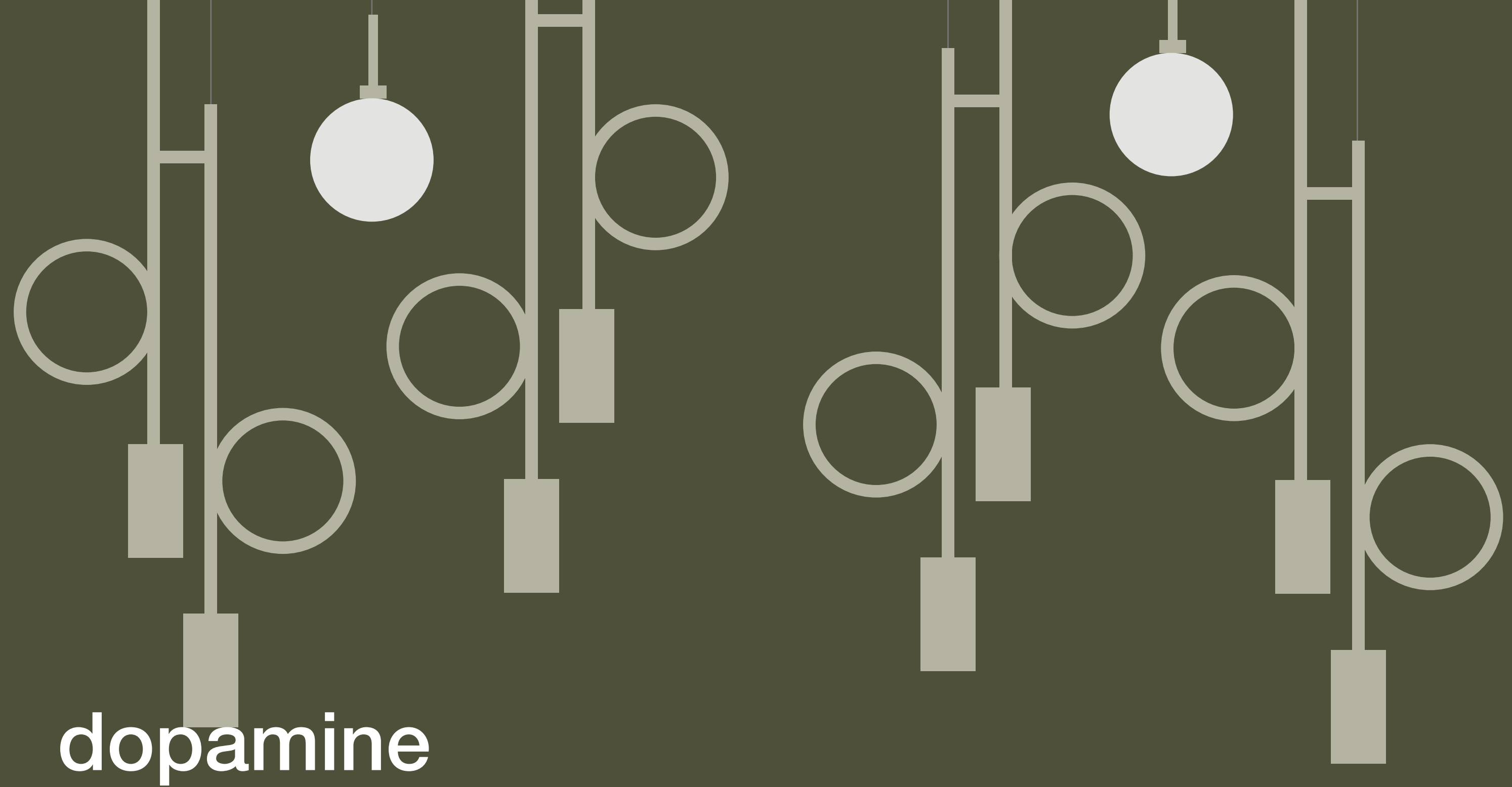

dopamine

la dopamina nasce nel movimento, nei sentieri immersi nella natura, nei viaggi verso l'altrove. La collezione ne cattura l'essenza: forme morbide, asimmetrie intrecciate, echi di piante esotiche. Un richiamo discreto al sole del sud, per portare armonia e meraviglia negli spazi di ogni giorno.

ALEXEY DANILIN

dopamine is born in movement, in paths immersed in nature, in journeys to the elsewhere. The collection captures its essence: soft shapes, interwoven asymmetries, echoes of exotic plants. A discreet call to the southern sun, to bring harmony and wonder to everyday spaces.

ALEXEY DANILIN

Dopamine Project S6+2



Dopamine Project S6+2



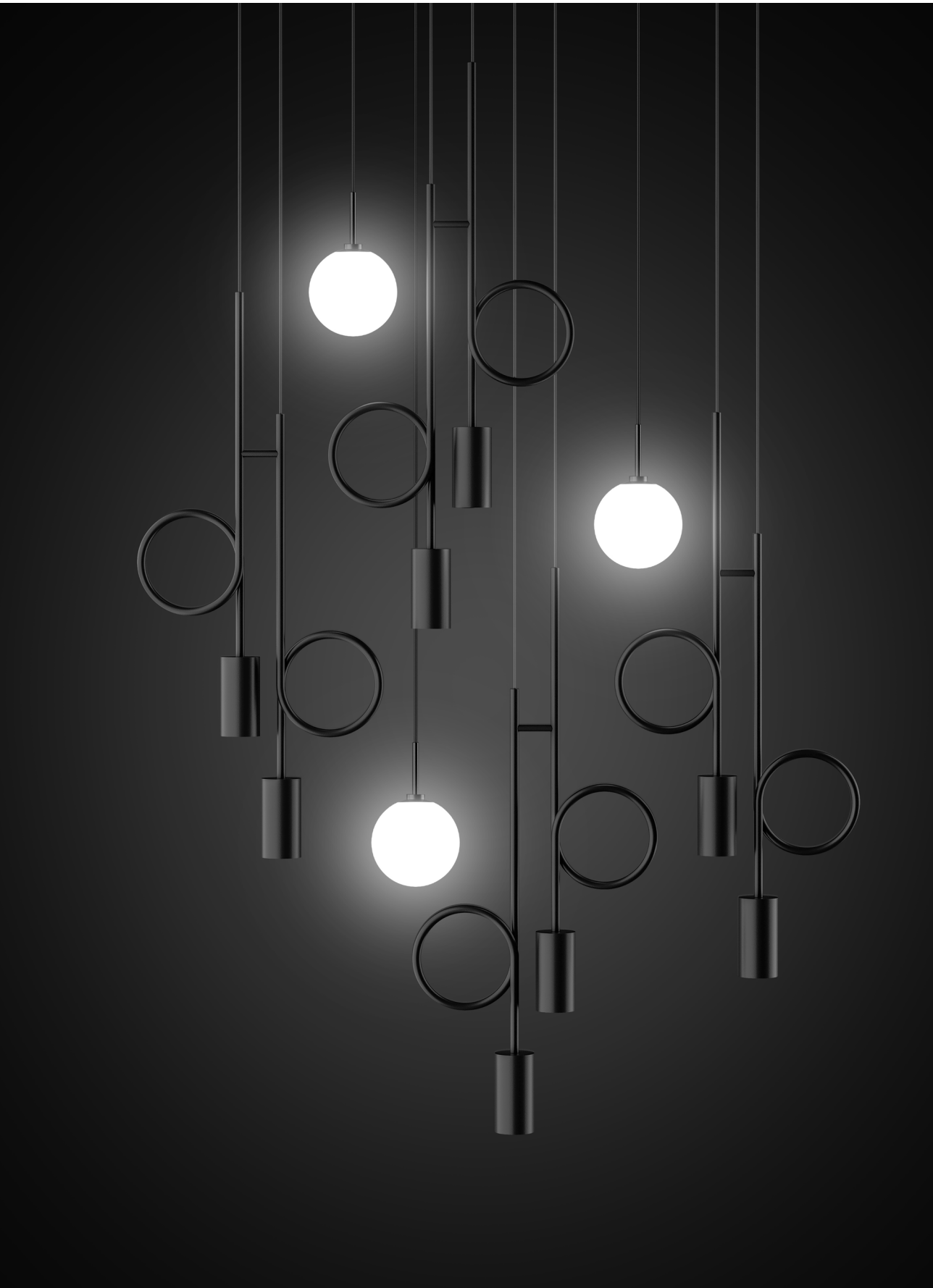

Dopamine S8+3

Dopamine S2 Dopamie S1





RAL 6034
Turquoise



RAL 1019
Cappuccino



RAL 6019
Green

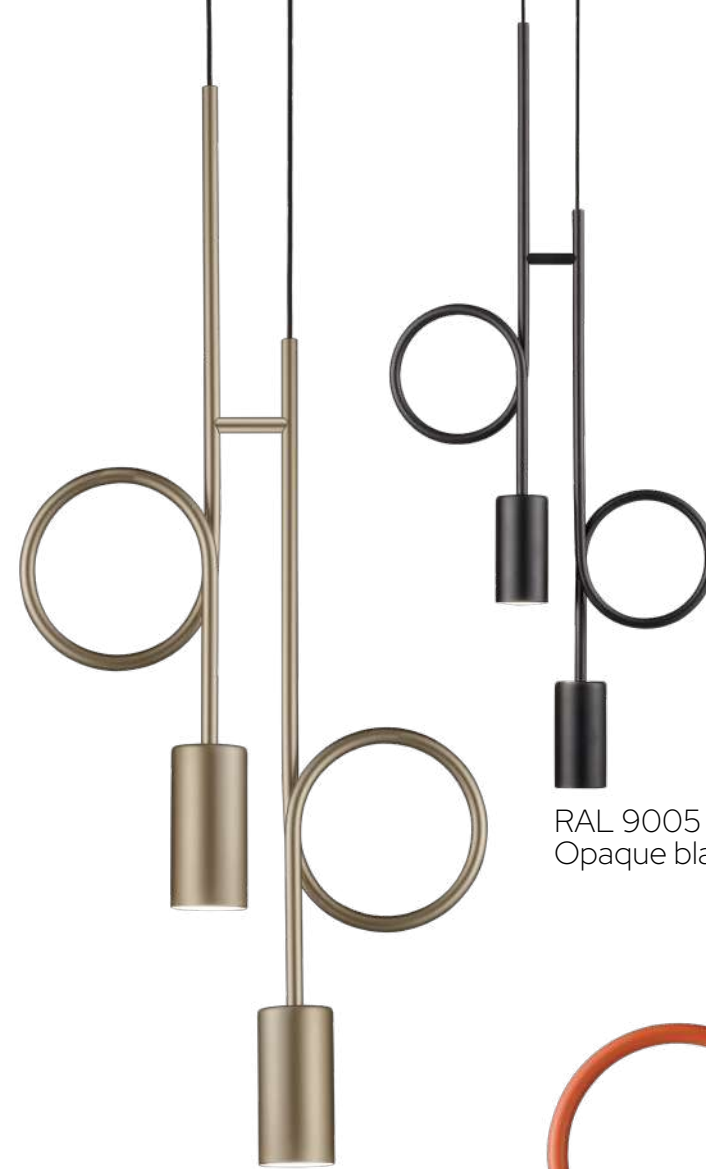

RAL Special
Oro Damian



RAL 9005
Opaque black



RAL 2010
Orange



RAL 3015
Baby pink



Dopamine wall lamp

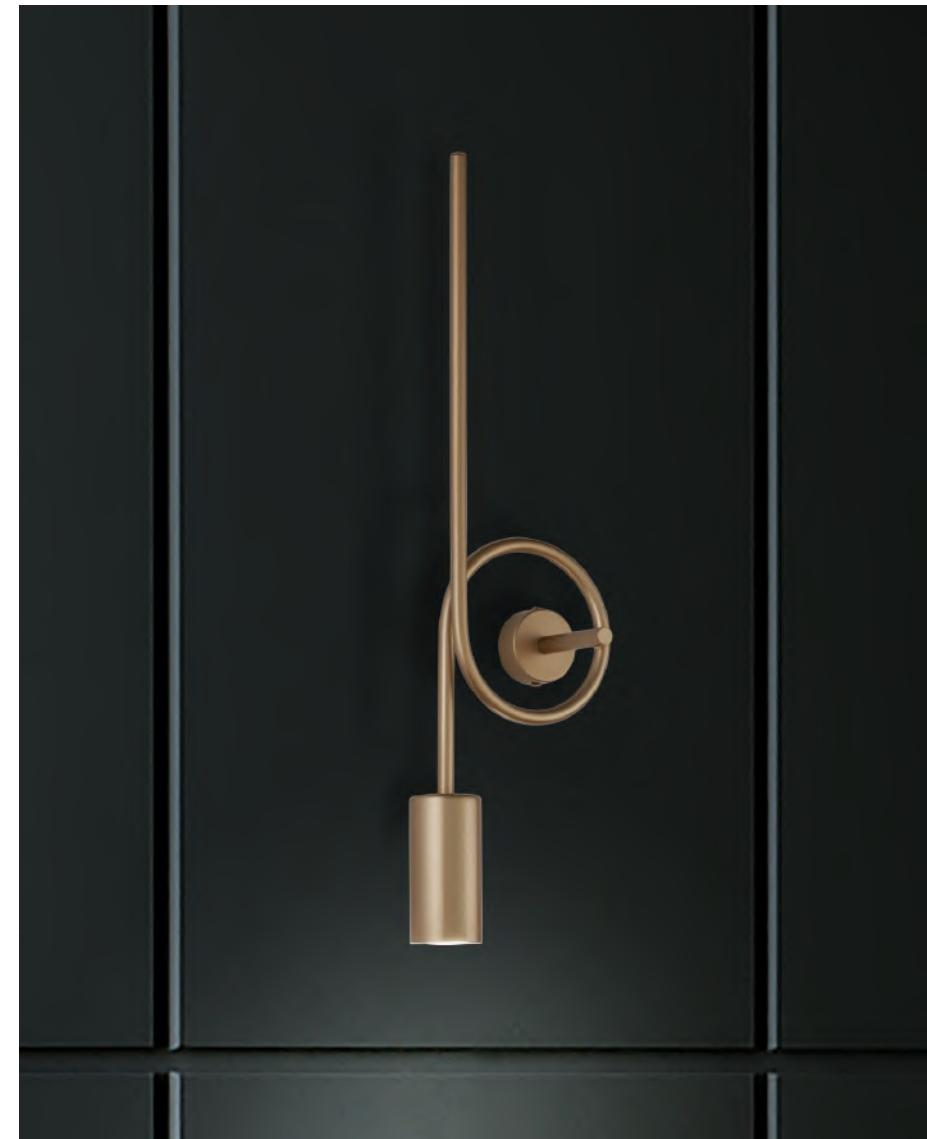

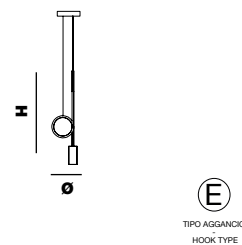

DOPAMINE S1

Ø 17 cm | 6,69"
H 62 cm | 24,40"

1 GU10 PAR 16 bulb x max 4W - 3000°K - 220 Vdc
- Dimmable: no - VOL: 0,105 m³ - 1 kg

Metal box Ø: 120 mm | 47,24" **H:** 30 mm | 1,81"

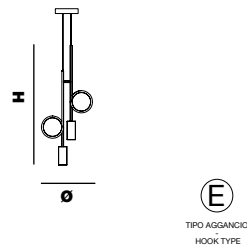

DOPAMINE S2

Ø 35 cm | 13,77"
H 80 cm | 31,49"

2 GU10 PAR 16 bulb x max 4W - 3000°K - 220 Vdc
- Dimmable: no - VOL: 0,105 m³ - 2 kg

Metal box Ø: 120 mm | 47,24" **H:** 30 mm | 1,81"

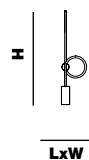

DOPAMINE WALL LAMP

LxW 17x11 cm | 6,69 x 4,33"
H 62 cm | 24,40"

1 GU10 PAR 16 bulb x max 4W - 3000°K - 220 Vdc
- Dimmable: no - VOL: 0,105 m³ - 1 kg

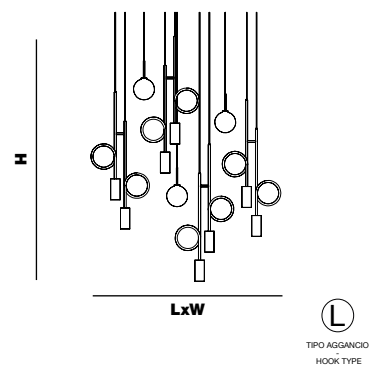

DOPAMINE PROJECT S8+3

LxW 110 x 25 cm | 43,30 x 9,84"
H 140 cm | 55,11"

8 GU10 PAR 16 bulb x max 4W + 3 G9 bulb - 3000°K -
220 Vdc - Dimmable: no - VOL: 0,26 m³ - 11 kg

Customisable configuration

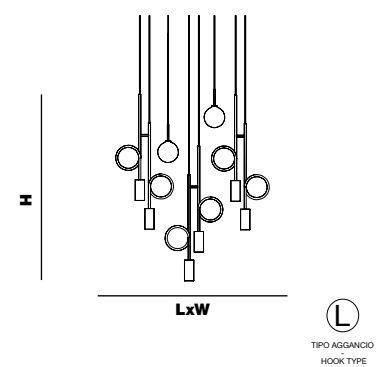

DOPAMINE PROJECT S6+2

LxW 90 x 25 cm | 35,43 x 9,84"
H 120 cm | 47,24"

6 GU10 PAR 16 bulb x max 4W + 2 G9 bulb - 3000°K -
220 Vdc - Dimmable: no - VOL: 0,26 m³ - 8 kg

Customisable configuration

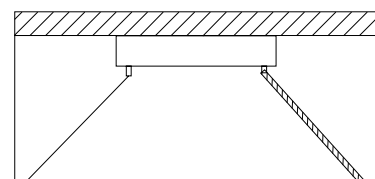

Altezza - Height
MIN 24 cm - 9,44"

E Aggancio con tirante e cavo di alimentazione per sospensioni (E)
Hook with metal cables and power cord for suspension (E)

L Aggancio da definire (L) - Hooks to be defined (L)

Dopamine

Alexey Danilin

Particolari - Details

Collezione in acciaio realizzata su disegno. Gli elementi sono curvati a mano da maestri artigiani su sagome. Saldature ad argento. Alcune componenti sono tornite e fresate. DOPAMINE S1 e DOPAMINE S2 hanno come fonte luminosa lampadine GU10 direzionate verso il basso. DOPAMINE project si arricchisce di sospensioni con sfera in borosilicato per illuminare l'intera composizione anche dall'alto. Dopamine è decorata successivamente in colori ral. E' possibile richiedere differenti colorazioni RAL.

Steel collection made to design. The elements are hand bent by master craftsmen on templates. Silver soldering. Some components are turned and milled. DOPAMINE S1 and DOPAMINE S2 have GU10 bulbs directed downwards as a light source. DOPAMINE project is enhanced with borosilicate sphere suspensions to illuminate the entire composition also from above. Dopamine is subsequently decorated in RAL colours. It is possible to request different RAL colours.

Metalli - Metals

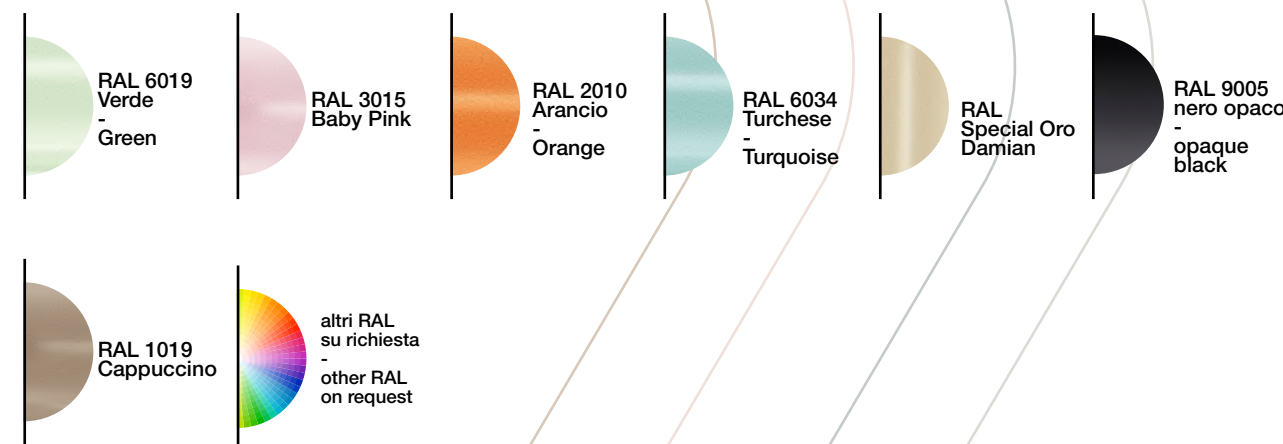

Color



Bianco latte
-
Milk white

* Specifiche agganci - Info on hooks pag. 134 - 135 *

* Altre finiture e colori su richiesta - Other finishes and colors on request - see pag. 136 -137 *

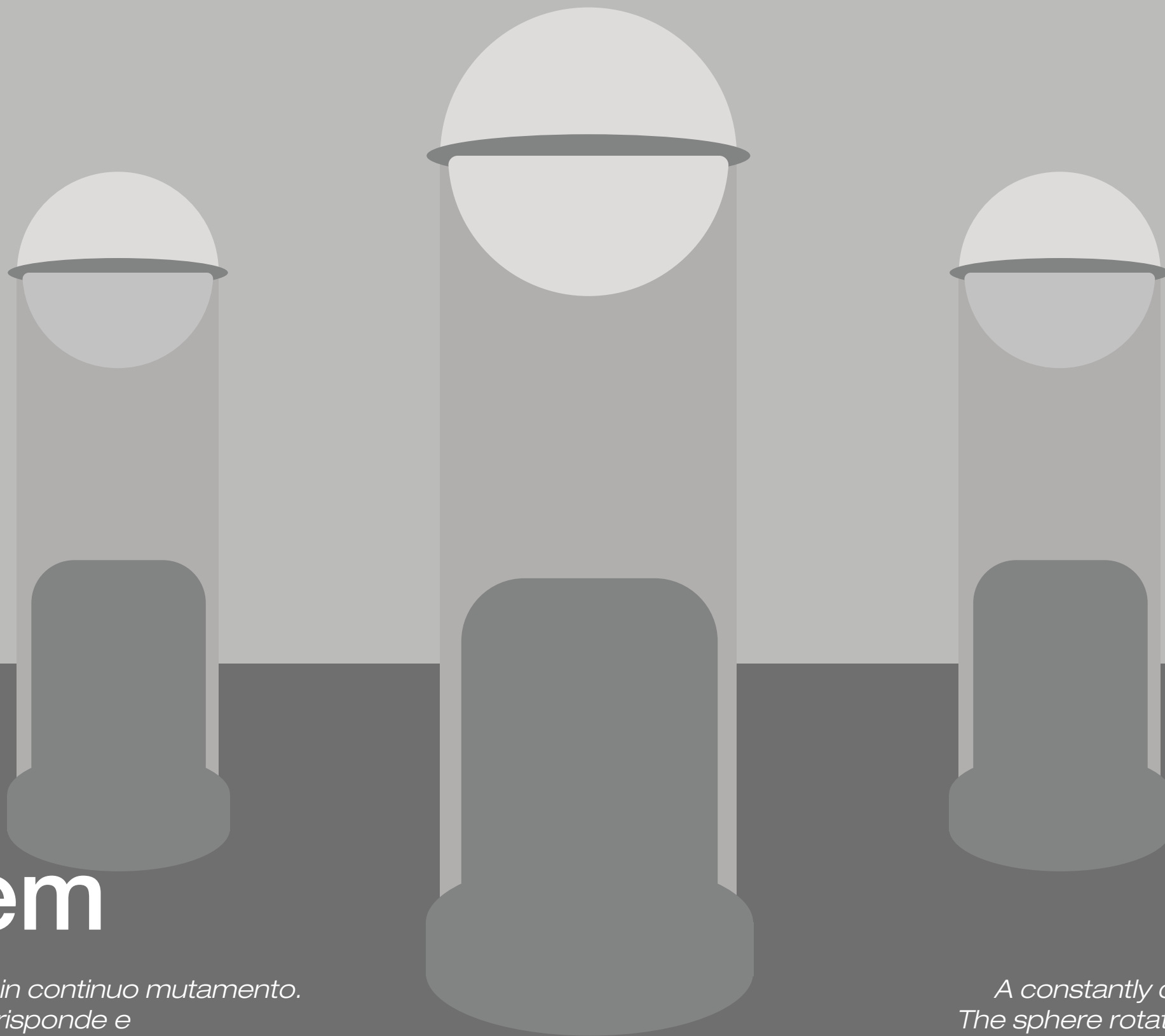

theorem

*Un frammento di luce in continuo mutamento.
La sfera ruota, la luce risponde e
si moltiplica in riflessi sempre nuovi.*

ALEXEY DANILIN

*A constantly changing fragment of light.
The sphere rotates, the light responds and
multiplies in ever new reflections.*

ALEXEY DANILIN





Theorem Lamp

Milk-white +
Metallic Chrome



RAL 9005
Opaque Black

Milk-white +
Metallic Gold



RAL 1019
Cappuccino

Milk-white +
Metallic Chrome



RAL 9010
White

Milk-white +
Metallic Gold



RAL Special
Brushed Bronze

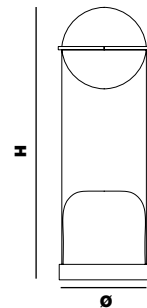

THEOREM LAMP

Ø 11 cm | 4,33"
H 31 cm | 12,20"

1 GU10 PAR 16 bulb x max 6W - 220 Vdc
Dimmable: no - VOL: 0,0608 m³ - 1 kg

Theorem

Alexey Danilin

Particolari - Details

Theorem è una collezione che nasce dallo studio della luce e la sua propagazione. La fonte luminosa inserita sulla base riflette su una sfera in borosilicato con doppia decorazione: oro lucido/cromo lucido – bianco latte. Ruotando manualmente la sfera e quindi la destinazione della luce si ottengono propagazioni differenti del fascio di luce. Base in legno tornita su disegno. Legno noce/frassino. Cilindro in vetro borosilicato; Diffusore in PMMA opalino tagliato laser.

Theorem is a collection born from the study of light and its propagation. The light source inserted on the base reflects on a borosilicate sphere with a double decoration: shiny gold/chrome - milk white. By manually rotating the sphere and thus the destination of the light, different propagations of the light beam are obtained. Wooden base turned to design. Walnut/ash wood. Borosilicate glass cylinder; laser-cut opaline PMMA diffuser.

Legno - Wood



Color

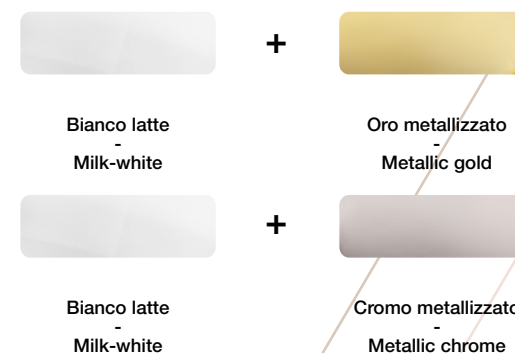

* Altre finiture e colori su richiesta - Other finishes and colors on request - see pag. 136 -137 *

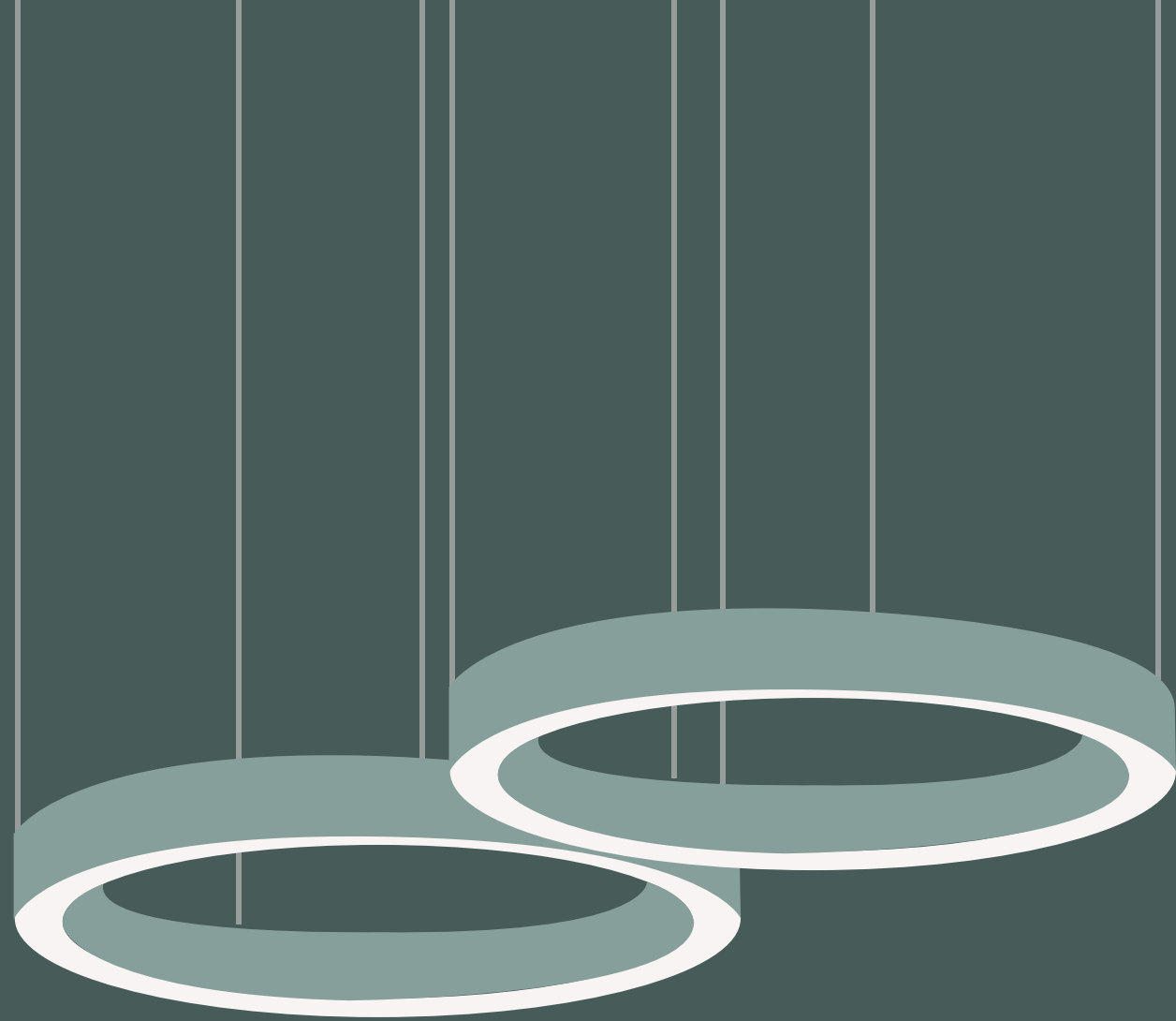

henos

Ispirato dai dettagli, il designer ama la forza delle piccole cose che insieme e unite formano una complessa creazione. Henos dal greco antico "henosis" che significa "unione". Unione del sole e della luna per un'eclissi e delle energie cosmiche per un "misterioso" buco nero.

MICHELE LOSITO

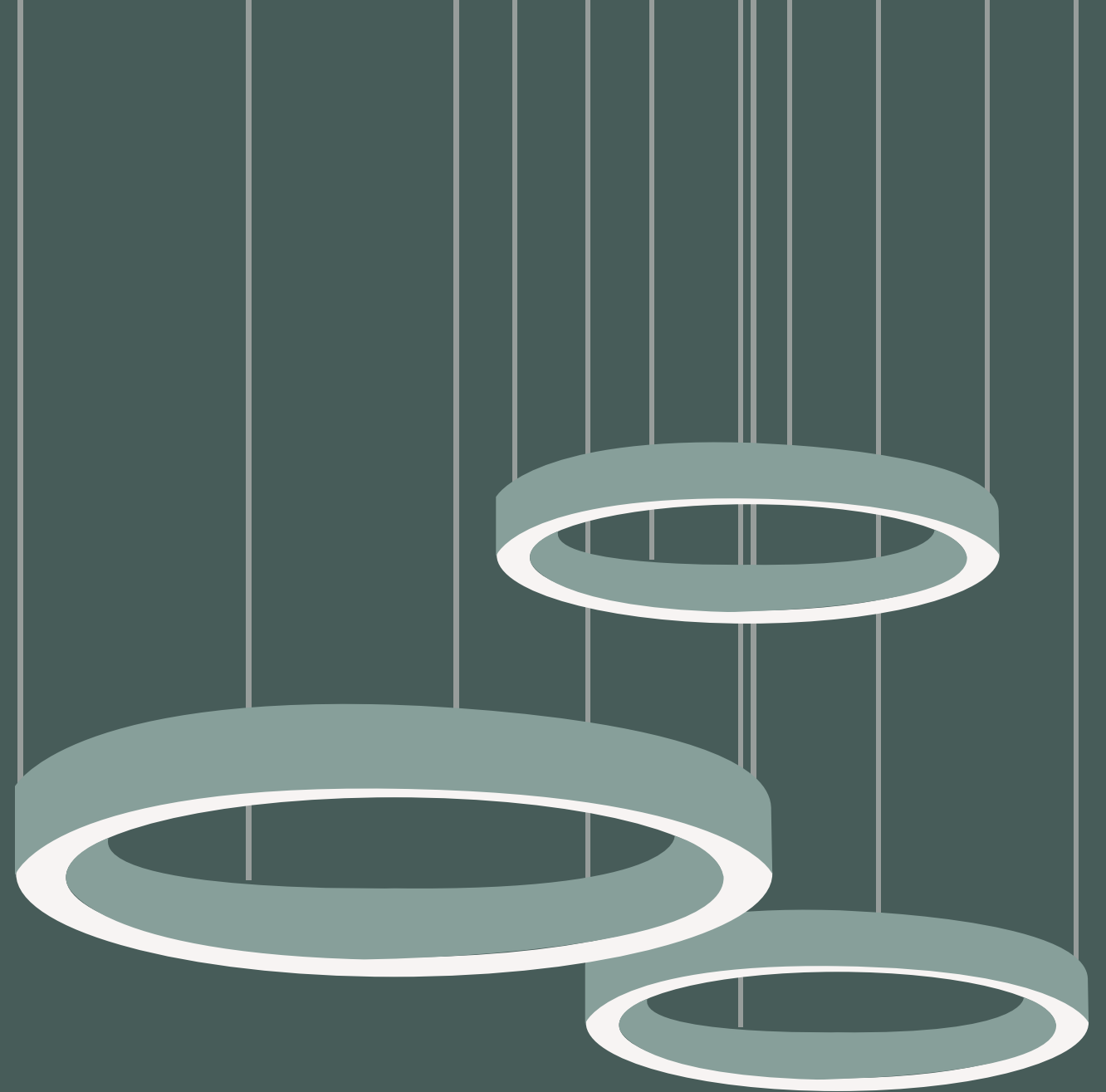

Inspired by details, the designer loves the power of small things that together and united form a complex creation. Henos from the ancient Greek "henosis" meaning "union". Union of the sun and moon for an eclipse and cosmic energies for a "mysterious" black hole.

MICHELE LOSITO

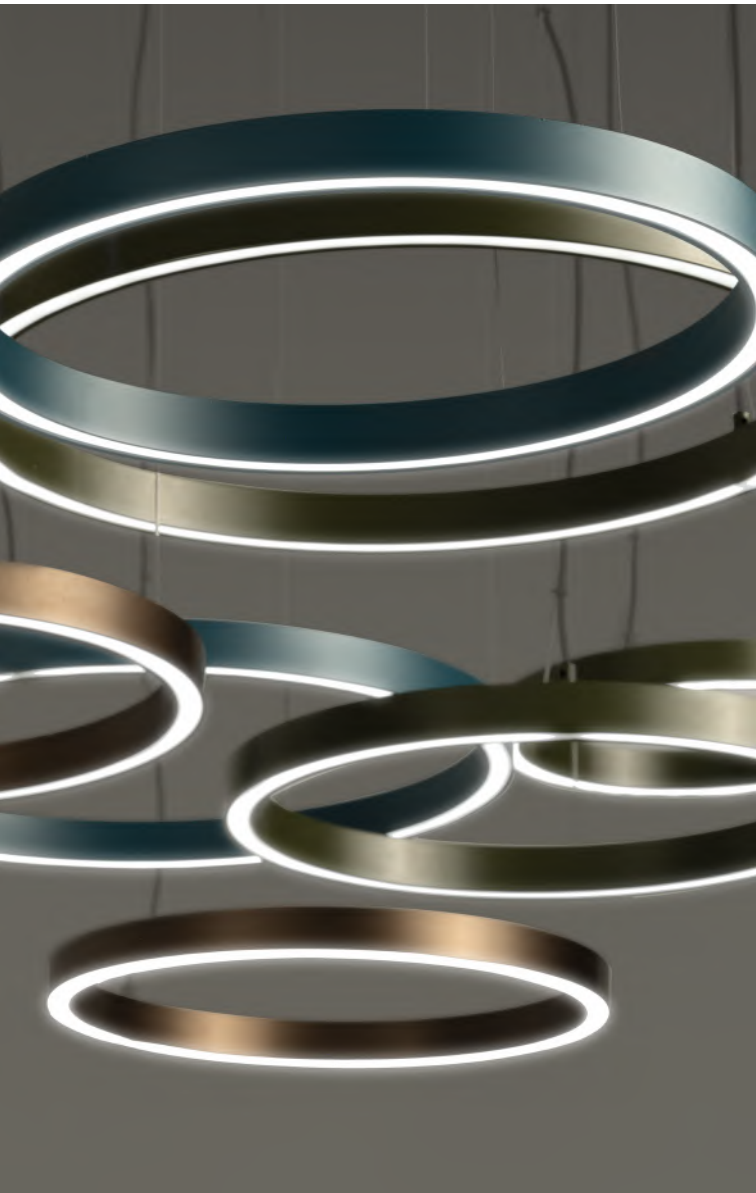

Henos 40 - Henos 32 - Henos 24



Henos 32





Henos Project S12



Henos Project S12

Henos

Michele Losito

Particolari - Details

Strutture in alluminio prodotte in Italia, tornite e fresare per alloggiare tubo flex luminoso. Disponibile in 3 diversi diametri: diametro 24 cm, diametro 32 cm, diametro 40 cm

*Per qualsiasi richiesta o differente versione non esitate a contattarci.

Aluminium structures made in Italy, turned and milled to accommodate flex tube lighting. Available in 3 different diameters: diameter 24 cm, diameter 32 cm, diameter 40 cm

*For any requests or different versions please do not hesitate to contact us.

Metalli - Metals

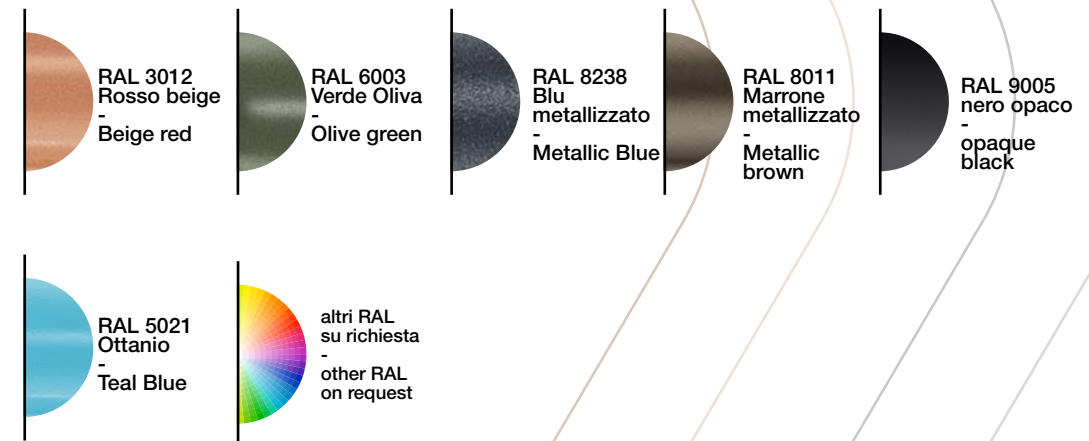

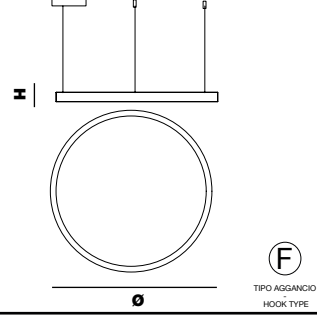

HENOS 40
 Ø 40 cm | 15,74"
 H 2.3 cm | 0,90"
 1 striped 17,6W - 4000°K - 24 Vdc
 2110 lm - Dimmable: on demand
 - Energy Efficiency: A++ - VOL: 0,0608 m³ - 2 kg
Metal box Ø: 150 mm | 5,90" H: 30 mm | 1,81"

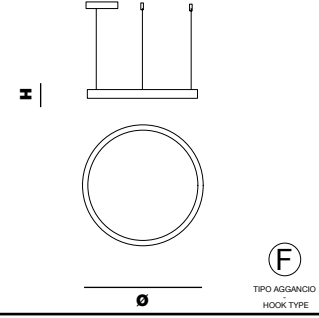

HENOS 32
 Ø 32 cm | 12,59"
 H 2.3 cm | 0,90"
 1 striped 14 W - 4000°K - 24 Vdc
 1685 lm - Dimmable: on demand
 - Energy Efficiency: A++ - VOL: 0,0608 m³ - 1,5 kg
Metal box Ø: 150 mm | 5,90" H: 30 mm | 1,81"

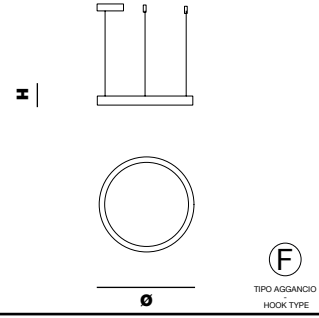

HENOS 24
 Ø 24 cm | 9,84"
 H 2.3 cm | 0,90"
 1 striped 10,6 W - 4000°K - 24 Vdc
 1268 lm - Dimmable: on demand
 - Energy Efficiency: A++ - VOL: 0,0233 m³ - 1 kg
Metal box Ø: 150 mm | 5,90" H: 30 mm | 1,81"

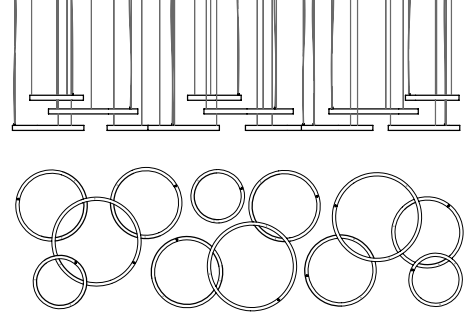

HENOS PROJECT S12
LxW 200 cm x 63 cm | 78,74" x 24,80"
H 16 cm | 6,29"
 168,8 W - 4000°K - 24 Vdc
 20,244 lm - Dimmable: on demand
 - Energy Efficiency: A++ - VOL: 0,196 m³ - 13,5 kg

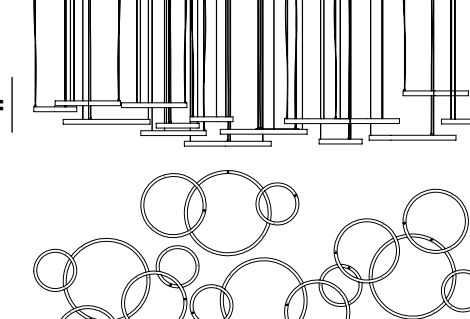

HENOS PROJECT S16
LxW 210 cm x 95 cm | 82,67" x 37,40"
H 26 cm | 10,23"
 218 W - 4000°K - 24 Vdc
 26.158 lm - Dimmable: on demand
 - Energy Efficiency: A++ - VOL: 0,196 m³ - 23 kg

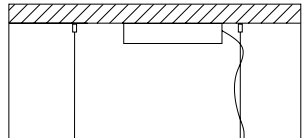

Altezza - Height
 MIN 24 cm - 9.44"

F Aggancio con rosone, tiranti e tasselli a soffitto; altezza regolabile (F) - Hook with ceiling cup, metal cables and ceiling cable gripper; adjustable height (F)

L Aggancio da definire (L) - Hooks to be defined (L)

* Specifiche agganci - Info on hooks pag. 134 - 135 *
 * Altre finiture e colori su richiesta - Other finishes and colors on request - see pag. 136 -137 *



nido

Nido è una lampada da tavolo progettata su due segni, un cerchio e una linea, che si incrociano l'uno all'altro in un equilibrio formale e senza regole. Il designer ha voluto esprimere la sensazione del comfort, quando si è nel proprio nido, liberi di creare.

SIMONE DI LIDDO

Nido is a table lamp designed based on two shapes, a circle and a line, which intersect with each other in a formal balance and without rules. The designer wanted to express the feeling of comfort, when you're in your own nest, free to create

SIMONE DI LIDDO

Nido Big Lamp: Dynamic white: 3000k - 4000k - 6000k



Nido Big Lamp





Nido Big Lamp

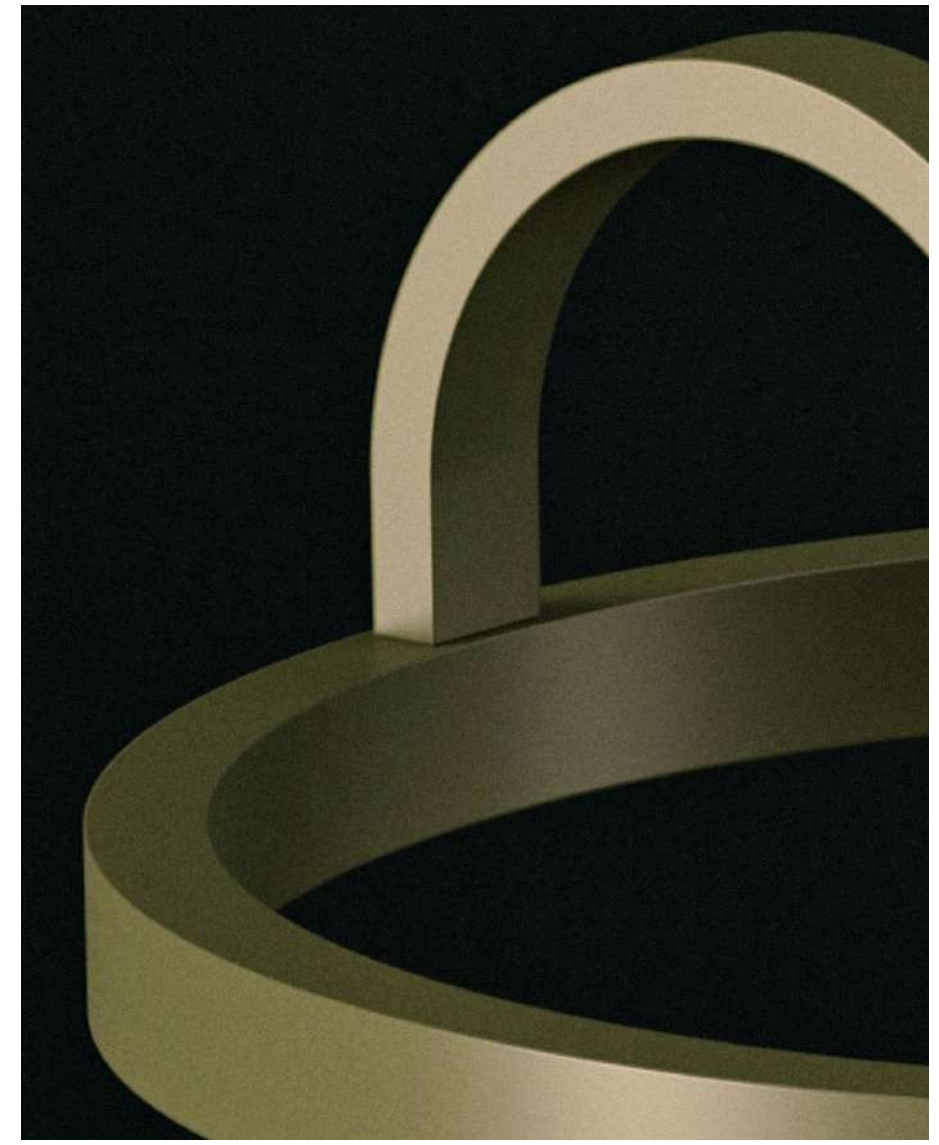

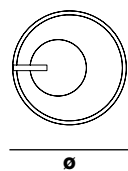
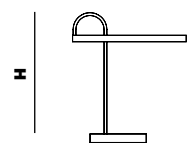

NIDO BIG LAMP

Ø 40 cm | 15,78"
H 46 cm | 18,11"

1 striped 17,6 W - dynamic white - 24 Vdc -
1947 lm - Dimmable: on demand - Energy Efficiency:
A++ - VOL: 0,1152 m³ - 3 kg

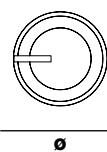
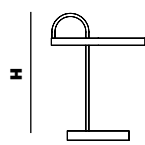

NIDO SMALL LAMP

Ø 32 cm | 12,59"
H 40 cm | 15,75"

1 striped 14 W - dynamic white - 24 Vdc
1700 lm - Dimmable: on demand - Energy Efficiency:
A++ - VOL: 0,1152 m³ - 2,7 kg

Nido

Simone Di Liddo

Particolari - Details

Lampada con componenti in ottone, alluminio, acciaio.

Braccio in ottone curvato manualmente su sagoma con saldature in argento

Anello in alluminio tornito e fresato per alloggiare neonflex, prodotto in Italia

All'interno è inserita una striped dynamic white per scegliere in maniera istantanea la temperatura della luce: da calda a fredda e dimmerabile controllata da telecomando.

* Per qualsiasi richiesta o differente versione non esitate a contattarci

Lamp with brass, aluminium, steel components.

Manually curved brass arm with silver soldering. Turned and milled aluminium ring to house neonflex, made in Italy. Inside there is a striped dynamic white to instantly choose the temperature of the light: from warm to cold.

* For any request or different version please contact us

Metalli - Metals



RAL 6003
Verde Oliva
- Olive green



RAL 8011
Marrone
metallizzato
- Metallic
brown



RAL 9005
nero opaco
- opaque
black



altri RAL
su richiesta
- other RAL
on request

* Altre finiture e colori su richiesta - Other finishes and colors on request - see pag. 136 -137 *

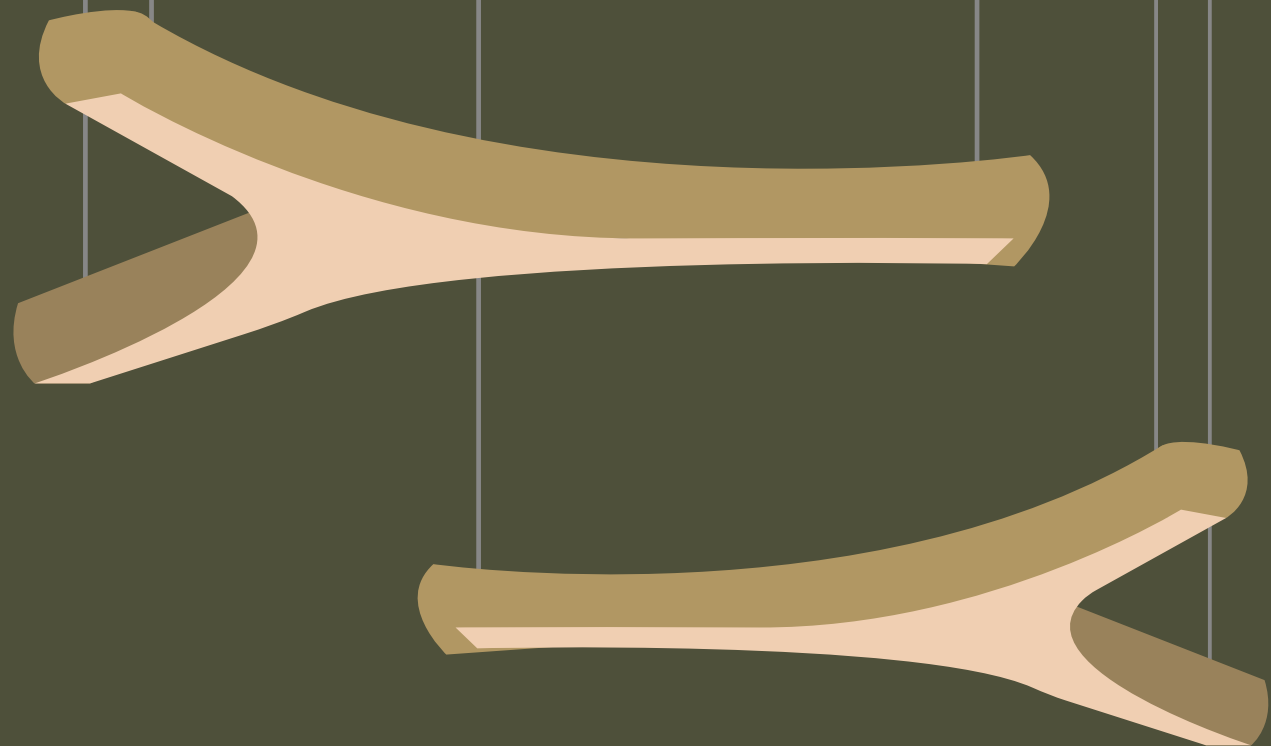

pegaso

Pegaso prende ispirazione dall'idea di associare la luce a quella delle stelle in cielo che da millenni disegnano nello spazio figure mitologiche e altre immagini, come la costellazione che dà il nome a questa lampada.

CRISTIAN VISENTIN

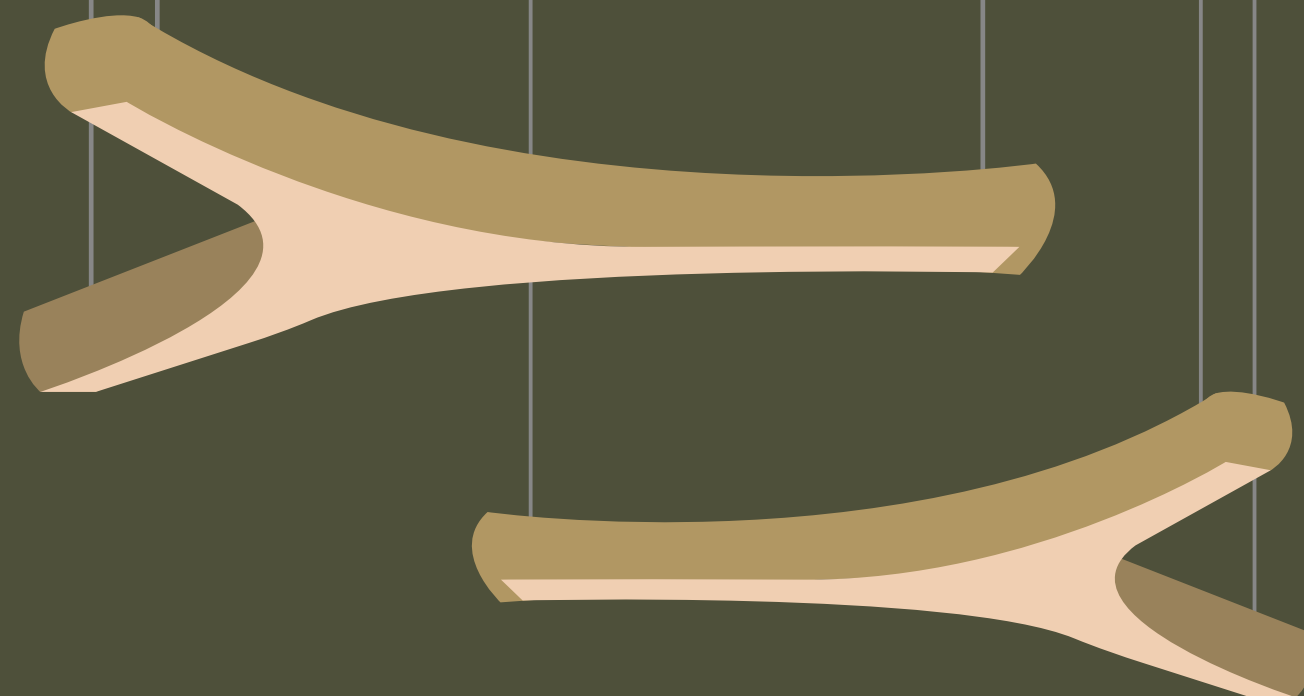

The Pegaso lamp is inspired by the idea of associating light with the stars in the sky, which for thousands of years have drawn mythological figures and other images in space, such as the constellation that gives this lamp its name.

CRISTIAN VISENTIN

Pegaso S1



Pegaso Project S5





Pegaso project S3





Pegaso Project S7



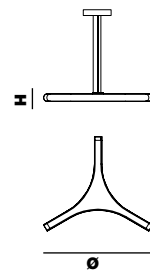

PEGASO S1

Ø 66 cm | 25,98"
H 4 cm | 1,57"

1 stripped 40W - 3000°K - 24 Vdc
5.200 lm - Dimmable: on demand
- Energy Efficiency: A++ - VOL: 0,196 m³ - 3 kg

Metal box Ø: 200 mm | 7,87" H: 40 mm | 1,57"

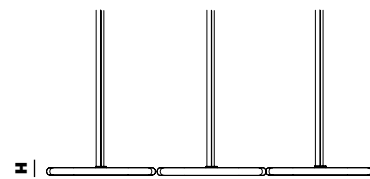

PEGASO PROJECT S3

LxW 175 cm x 80 cm | 68,89" x 31,49"
H 4 cm | 1,57"

3 stripped 120W - 3000°K - 24 Vdc
15.600 lm - Dimmable: on demand - Energy Efficiency:
A++ - VOL: 0,196 m³ - 9 kg

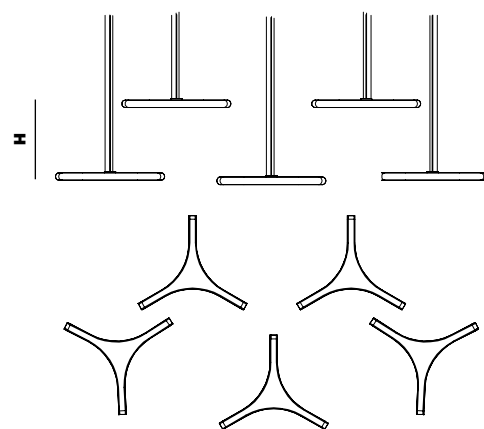

PEGASO PROJECT S5

LxW 170 cm x 120 cm | 66,92" x 47,24"
H 22 cm | 8,66"

5 stripped 200W - 3000°K - 24 Vdc
26.000 lm - Dimmable: on demand - Energy Efficiency:
A++ - VOL: 0,324 m³ - 15 kg

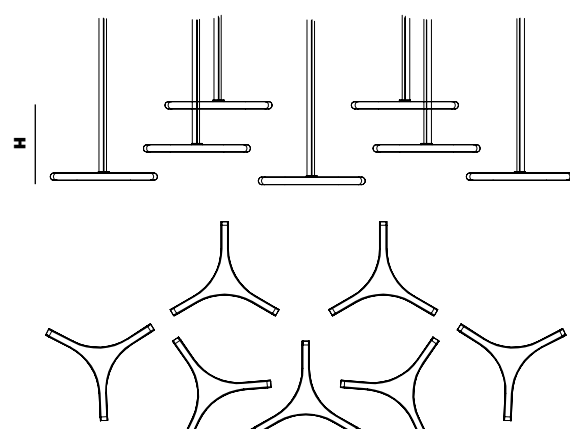

PEGASO PROJECT S7

LxW 225 cm x 140 cm | 88,58" x 55,11"
H 40 cm | 15,74"

7 stripped 280W - 3000°K - 24 Vdc
36.400 lm - Dimmable: on demand - Energy Efficiency:
A++ - VOL: 0,324 m³ - 21 kg

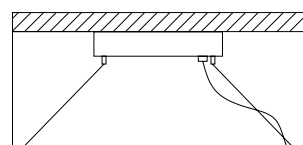

Altezza - Height
MIN 24 cm - 9,44"



Aggancio con rosone o scatola e tiranti per sospensioni. Altezza regolabile (C)
Hook with ceiling cup or metal box and metal cables for suspension. Adjustable height (C)



Aggancio da definire (L) - Hooks to be defined (L)

Pegaso

Cristian Visentin

Particolari - Details

Pegaso è una collezione interamente made in Italy: strutture in alluminio tornite e successivamente curvate a mano da maestri artigiani. Boccole in alluminio tornite e fresate. Vetro cattedrale martellato made in Veneto tagliato a idrogetto su disegno.

Pegaso is a collection entirely made in Italy: turned aluminium structures, hand bent by master craftsmen. Turned and milled aluminium bushings. Hammered cathedral glass made in Veneto water-jet cut to design.

Metalli - Metals

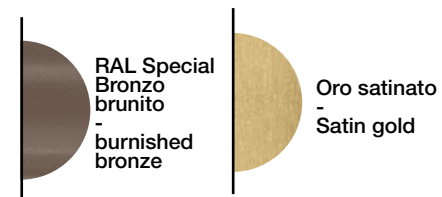

Color



Bianco latte satinato
Milk-white satin

* Specifiche agganci - Info on hooks pag. 134 - 135 *

* Altre finiture e colori su richiesta - Other finishes and colors on request - see pag. 136 -137 *



Bubbles S6



Bubbles S1



Bubbles LG1





Bubbles LG2







Bubbles A3

Bubbles A2



105



Bubbles S4



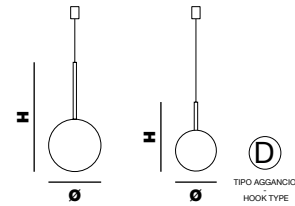

BUBBLES S1 BIG - S1 SMALL

Ø 20 cm | 7,87" / 12 cm | 4,72"
H 36 cm | 14,17" / 28 cm | 11,02"

1 G9 bulb not included

Metal box Ø: 55 mm | 21,65" H: 80 mm | 3,14"

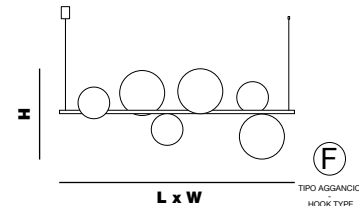

BUBBLES S6

L x W 122 cm x 40 cm | 48,03" x 15,75"
H 40 cm | 15,75"

6 G9 bulb not included

Metal box Ø: 55 mm | 21,65" H: 80 mm | 3,14"

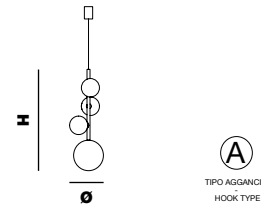

BUBBLES S4

Ø 26 cm | 7,87"
H 68 cm | 26,77"

4 G9 bulb not included

Metal box Ø: 55 cm | 21,65" H: 80 mm | 3,14"

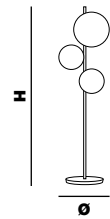

BUBBLES PT3

Ø 30 cm | 11,81"
H 165 cm | 64,69"

3 G9 bulb not included

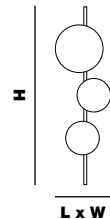

BUBBLES A3

L x W 20,5 cm x 24 cm | 8,07" x 9,45"
H 66 cm | 25,98"

3 G9 bulb not included

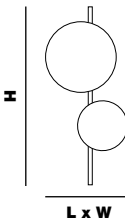

BUBBLES A2

L x W 20,5 cm x 24 cm | 8,07" x 9,45"
H 46 cm | 18,11"

2 G9 bulb not included

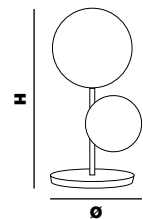

BUBBLES LG2

Ø 21 cm | 8,07"
H 48 cm | 18,90"

2 G9 bulb not included

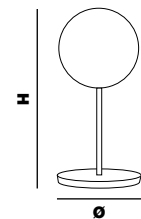

BUBBLES LG1

Ø 20 cm | 7,87"
H 48 cm | 18,90"

1 G9 bulb not included

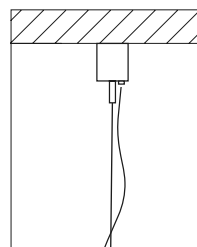

Altezza - Height
MIN 10 cm - 3,93"

Aggancio con rosone o scatola in metallo e tirante in metallo; altezza regolabile (A) - Hook with ceiling cup or metal box and metal cable; adjustable height (A)

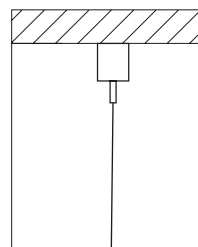

Altezza - Height
MIN 10 cm - 3,93"

Aggancio con rosone o scatola a soffitto e cavo di alimentazione; altezza regolabile (D) - Hook with ceiling cup and power cord; adjustable height (D)

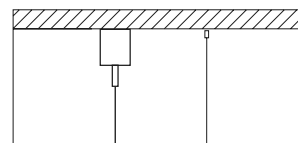

Altezza - Height
MIN 10 cm - 3,93"

Aggancio con rosone, tiranti e tasselli a soffitto; altezza regolabile (F) - Hook with ceiling cup, metal cables and ceiling cable gripper; adjustable height (F)



bubbles

Studio in Project

Particolari - Details

Strutture in ferro realizzate artigianalmente su disegno. Sfere in borosilicato con finitura satinata. Boccole portalampadine in ottone tornito. Per qualsiasi richiesta o differente versione non esitate a contattarci.

Handcrafted iron structures made on our drawing. Borosilicate spheres with satin finish. Led holder bushings made of turned brass. For any inquiries or different versions, please do not hesitate to contact us.

Metalli - Metals

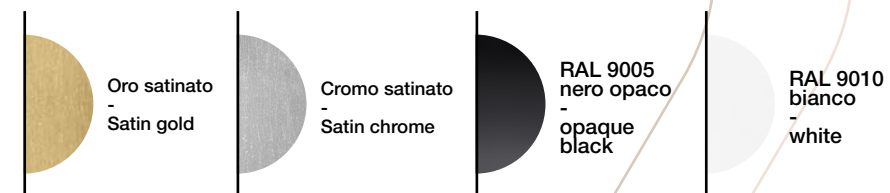

Vetro - Glass

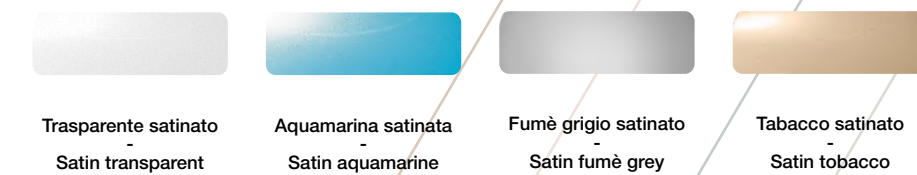

* Specifiche agganci - Info on hooks pag. 134 - 135 *

* Altre finiture e colori su richiesta - Other finishes and colors on request - see pag. 136 -137 *

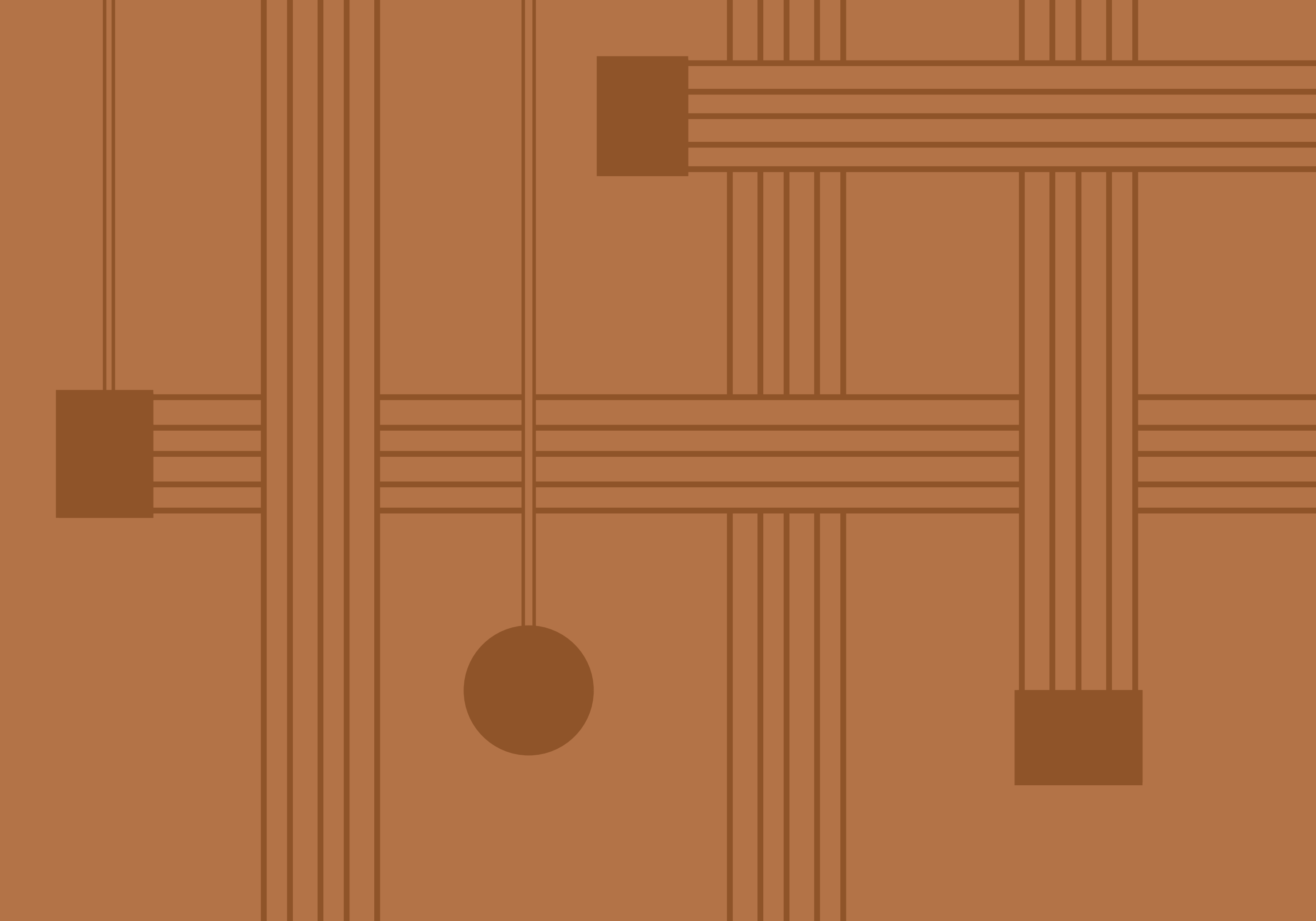



Trama S8 Grid



Trama project S8 grid x 2



Trama project on demand





Trama S9

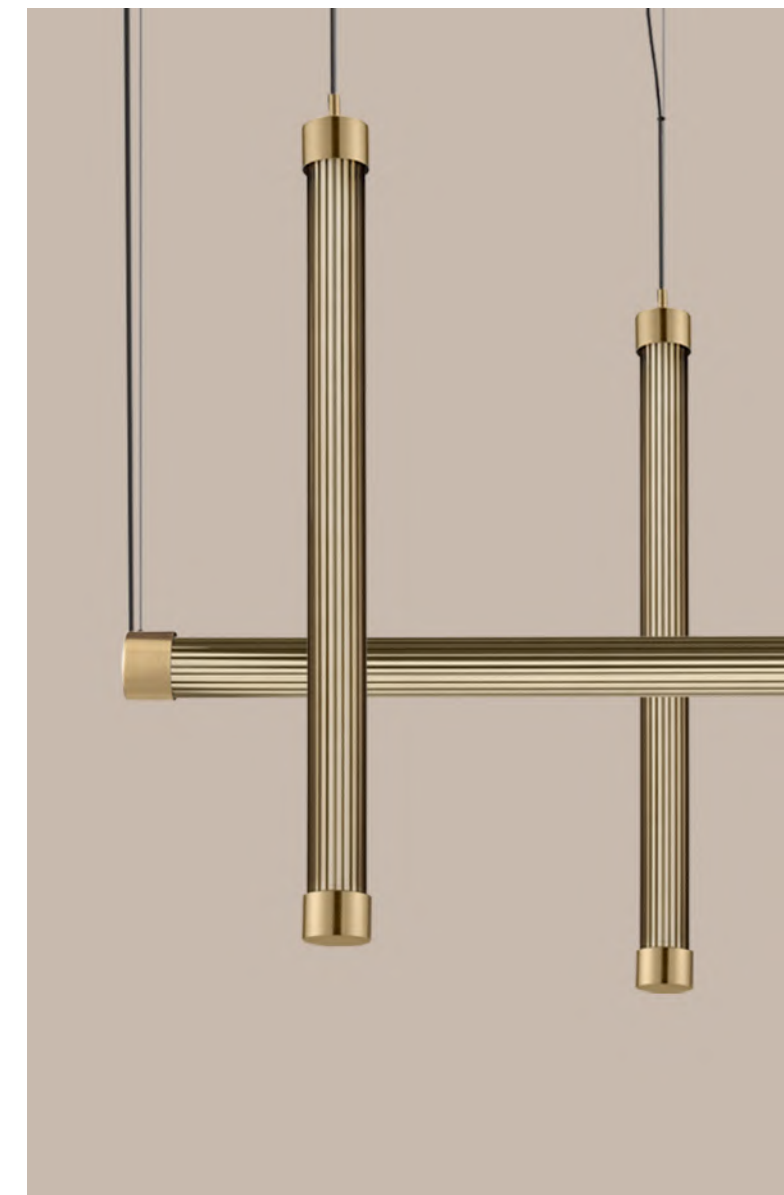





124

trama

Trama wall lamp 120 x 2

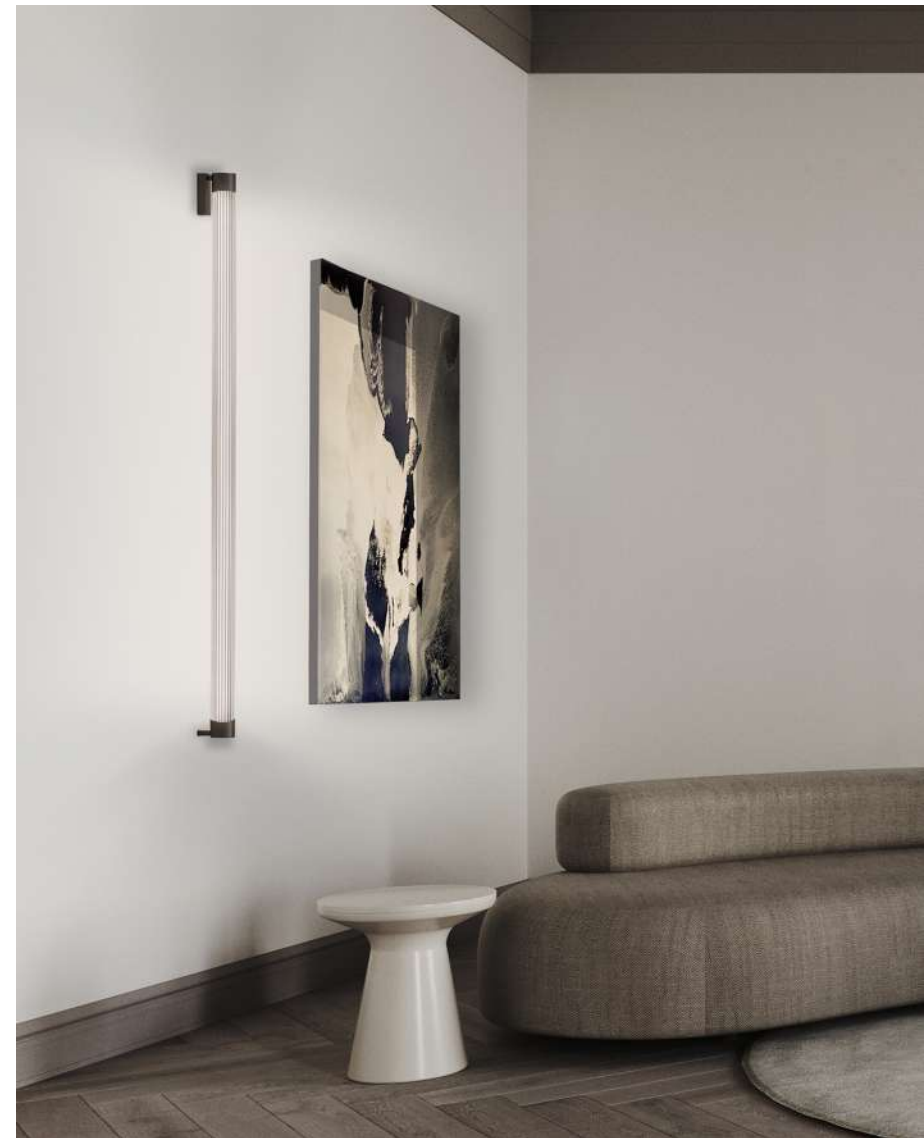

125

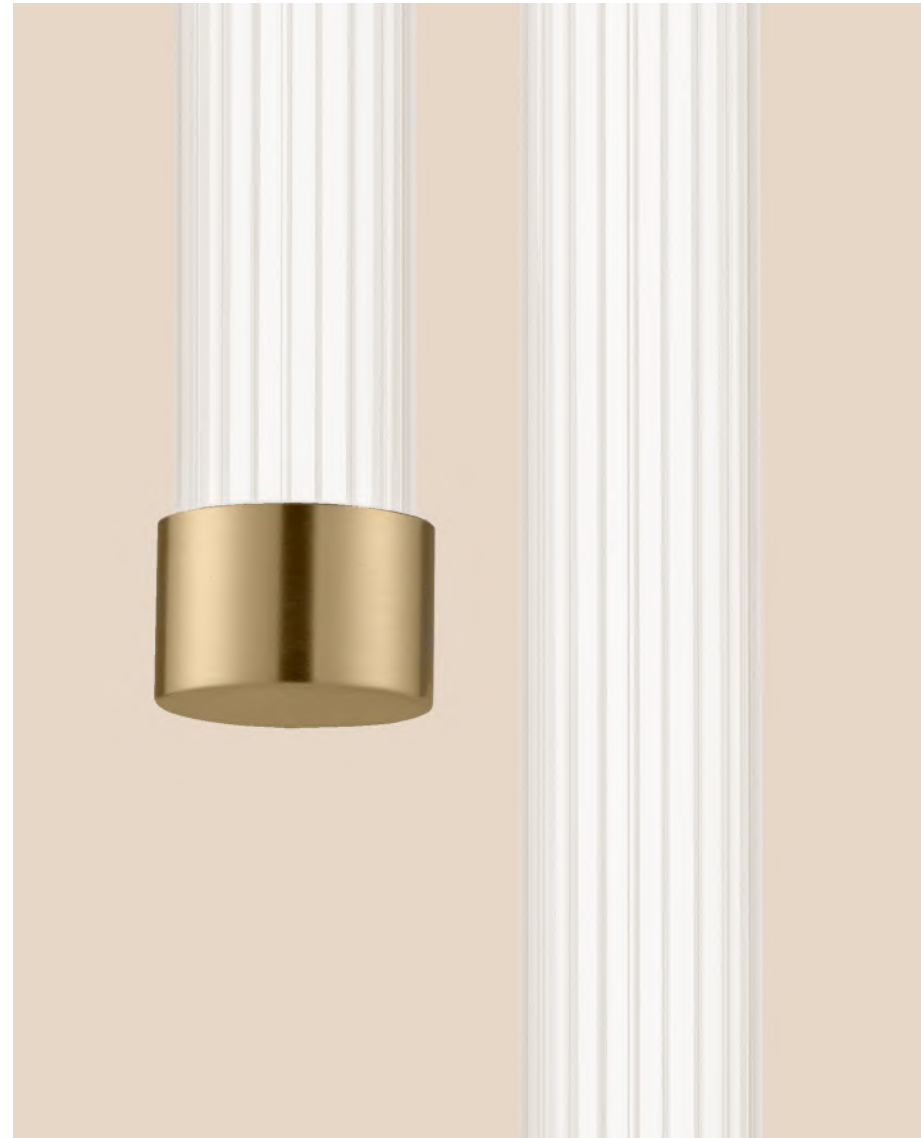



Trama project S8 grid x 5



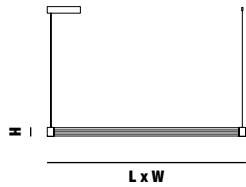

TRAMA S1 A
L x W 126 cm x 6 cm | 49,61" x 2,36"
H 6 cm | 2,36"

360° neon flex 21,6W - 3000°K - 24 Vdc - SMD 2835T
 2536,8 lm - life time 50.000 hrs - Dimmable: on demand
 - Energy Efficiency: A++ - VOL: 0,052 m³ - 2,5 Kg

Metal box LxW: 150 mm x 70 mm | 2,75" x 5,90"
H: 35 mm | 1,37"

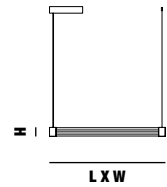

TRAMA S1 B
L x W 75 cm x 6 cm | 29,53" x 2,36"
H 6 cm | 2,36"

360° neon flex 12,6W - 3000°K - 24 Vdc - SMD 2835T
 1480 lm - life time 50.000 hrs - Dimmable: on demand
 - Energy Efficiency: A++ - VOL: 0,105 m³ - 2 Kg

Metal box LxW: 150 mm x 70 mm | 2,75" x 5,90"
H: 35 mm | 1,37"

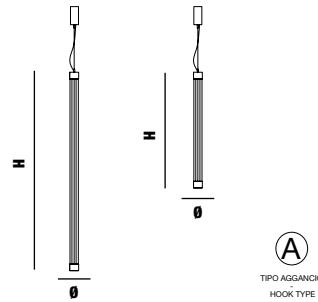

TRAMA S1 C - S1 D
Ø 6 cm | 2,36"
H 127 cm | 50" / 76 cm | 29,92"

360° neon flex 21,6W/12,6W - 3000°K - 24 Vdc - SMD 2835T - 2536,8 lm/1480 lm - life time 50.000 hrs - Dimmable: on demand - Energy Efficiency: A++ - VOL: 0,052 m³ / 0,105 m³ - 2,5 Kg/2 Kg

Metal box Ø: 70 mm | 2,75" **H:** 160 mm | 6,29"

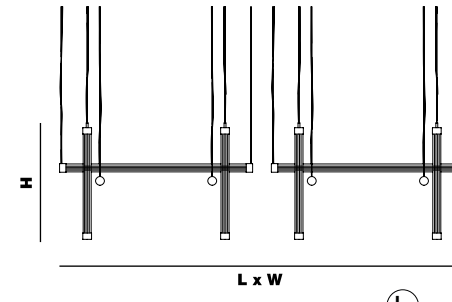

TRAMA S8 GRID X2

L x W 300 cm x 126 cm | 118,11" x 49,60"
H 76 cm | 29,92"

16 - 360° neon flex 274W - 3000°K - 24 Vdc - SMD 2835T
 32.136 lm - life time 50.000 hrs - Dimmable: on demand - Energy Efficiency: A++ - VOL: 0,882 m³ - 36 Kg

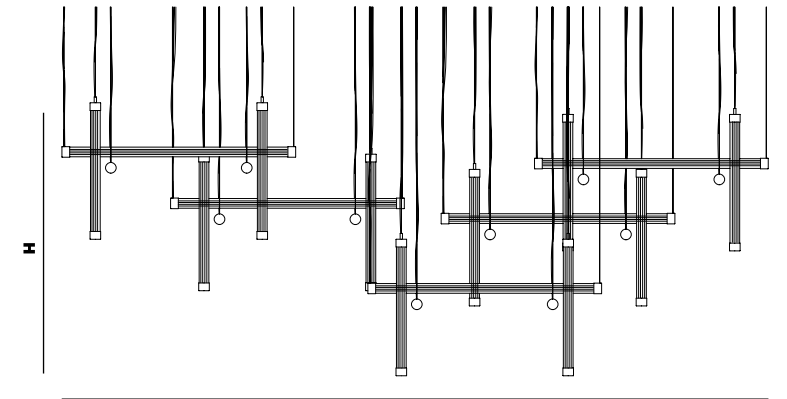

TRAMA S8 GRID X5

L x W 365 cm x 230 cm | 143,70" x 90,55"
H 145 cm | 57,08"

40 - 360° neon flex 685W - 3000°K - 24 Vdc - SMD 2835T
 80.340 lm - life time 50.000 hrs - Dimmable: on demand
 - Energy Efficiency: A++ - VOL: 1,764 m³ - 90 Kg

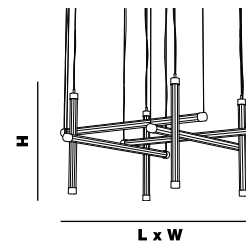

TRAMA S8 GRID

L x W 126 cm x 126 cm | 49,61" x 49,61"
H 76 cm | 29,92"

8 - 360° neon flex 137W - 3000°K - 24 Vdc - SMD 2835T
 16068 lm - life time 50.000 hrs - Dimmable: on demand
 - Energy Efficiency: A++ - VOL: 0,882 m³ - 18 Kg

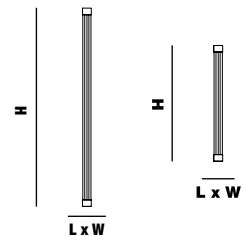

TRAMA WALL LAMP 120 - 70

L x W 6 cm x 8 cm | 2,36" x 3,15"
H 126 cm | 49,61" / 75 cm | 29,53"

360° neon flex 21,6W/12,6W - 3000°K - 24 Vdc - SMD 2835T - 2536,8 lm/1480 lm - life time 50.000 hrs - Dimmable: on demand - Energy Efficiency: A++ - VOL: 0,3 m³/0,1125 m³ - 2,5 Kg/2 Kg

*standard version comes with remote LED driver.
 You can request a version with integrated LED driver.

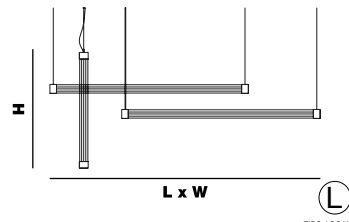

TRAMA S3

L x W 160 cm x 33 cm | 62,99" x 12,99"
H 76 cm | 29,92"

3 - 360° neon flex 55,8W - 3000°K - 24 Vdc - SMD 2835T
 6353,6 lm - life time 50.000 hrs - Dimmable: on demand
 - Energy Efficiency: A++ - VOL: 0,441 m³ - 7 Kg

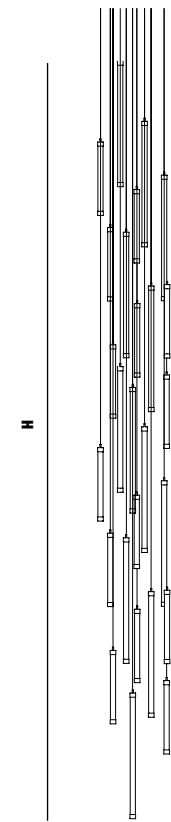

TRAMA S28

Ø 80 cm | 31,49"
H 800 cm | 314,96"

28 - 360° neon flex 442,8W - 3000°K - 24 Vdc - SMD 2835T
 52008 lm - life time 50.000 hrs - Dimmable: on demand
 - Energy Efficiency: A++ - VOL: 1,764 m³ - 61 Kg

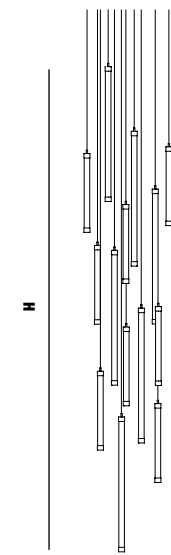

TRAMA S14

Ø 80 cm | 31,49"
H 485 cm | 190,94"

14 - 360° neon flex 221,4W - 3000°K - 24 Vdc - SMD 2835T
 26004 lm - life time 50.000 hrs - Dimmable: on demand
 - Energy Efficiency: A++ - VOL: 0,882 m³ - 30,5 Kg

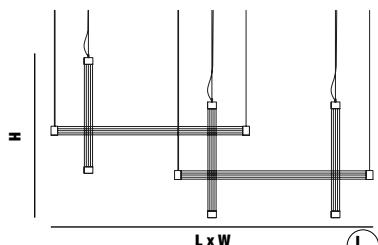

TRAMA S5

L x W 210 cm x 50 cm | 82,67" x 19,68"
H 86 cm | 33,85"

5 - 360° neon flex 81W - 3000°K - 24 Vdc - SMD 2835T
 9513,6 lm - life time 50.000 hrs - Dimmable: on demand
 - Energy Efficiency: A++ - VOL: 0,5513 m³ - 11 Kg

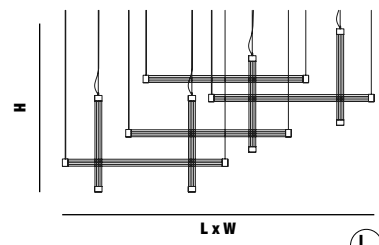

TRAMA S8

L x W 230 cm x 83 cm | 90,55" x 32,67"
H 114 cm | 44,88"

8 - 360° neon flex 137W - 3000°K - 24 Vdc - SMD 2835T
 16068 lm - life time 50.000 hrs - Dimmable: on demand
 - Energy Efficiency: A++ - VOL: 1,26 m³ - 18 Kg

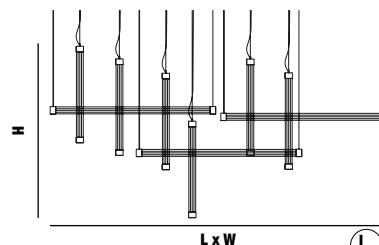

TRAMA S9

L x W 240 cm x 94 cm | 94,48" x 37"
H 114 cm | 44,88"

9 - 360° neon flex 140,5W - 3000°K - 24 Vdc - SMD 2835T
 16490,4 lm - life time 50.000 hrs - Dimmable: on demand
 - Energy Efficiency: A++ - VOL: 0,882 m³ - 20 Kg

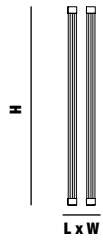

TRAMA WALL LAMP 120 X2

L x W 15 cm x 8 cm | 5,90" x 3,14"
H 126 cm | 49,60"

2 - 360° neon flex 43,2W - 3000°K - 24 Vdc - SMD 2835T
 5.073,6 lm - life time 50.000 hrs - Dimmable: on demand -
 - Energy Efficiency: A++ - VOL: 0,3 m³ - 5 Kg

*standard version comes with remote LED driver.
 You can request a version with integrated LED driver.

trama

Studio in Project

Particolari - Details

Trama è una collezione composta da elementi singoli in differenti lunghezze ma che affiancati possono strutturare progetti ad-hoc anche di estese dimensioni. Ricreano nell'aria una trama luminosa personalizzabile. Gli elementi di Trama sono in borosilicato trasparente o decorato e all'estremità sono inserite le bocche in alluminio tornito e le cover in metallo stampato. L'elemento luminoso è un Neonflex 360° ed illumina il tubo in borosilicato per tutta la sua lunghezza. Trama è già disponibile nelle misure indicate nei disegni. Per qualsiasi richiesta o differente versione non esitate a contattarci.

Trama is a collection made up of single elements in different lengths but which, when placed side by side, can create ad hoc projects even of large sizes. They recreate a customizable light pattern in the air. Trama's elements are made of transparent or colored borosilicate glass with turned aluminum bushings and molded metal covers at the ends. The light source is a 360° Neonflex, that lights up the borosilicate tube along its whole length. Trama is already available in the sizes shown in the drawings. Do not hesitate to contact us for any request or different version.

Metalli - Metals

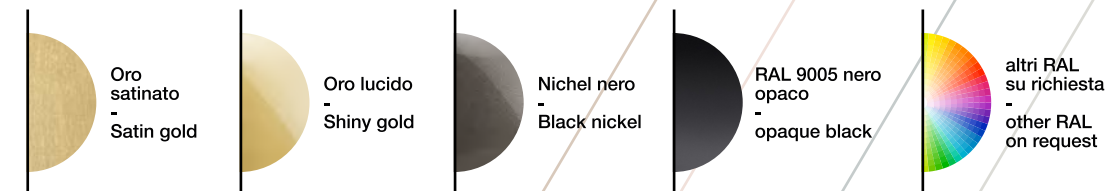

Vetro - Glass

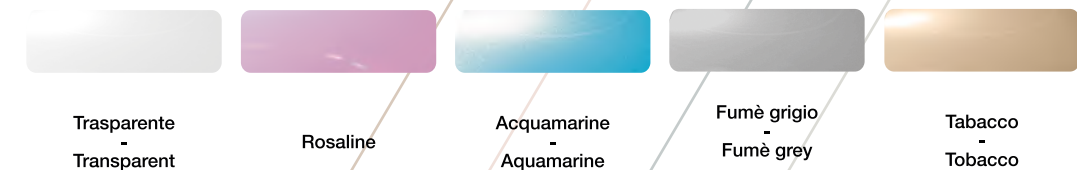

A Altezza - Height
 MIN 30 cm - 11.8"
 Aggancio con rosone o scatola in metallo e tirante in metallo; altezza regolabile (A)
 - Hook with ceiling cup or metal box and metal cable; adjustable height (A)
 * rosone cilindrico Ø7 H16 cm
 - cylindrical metal box Ø7 H16 cm

F Altezza - Height
 MIN 24 cm - 9.44"
 Aggancio con rosone, tiranti e tasselli a soffitto; altezza regolabile (F) - Hook with ceiling cup, metal cables and ceiling cable gripper; adjustable height (F)
 * rosone scatola rettangolare L15 W7 H3,5 cm - rectangular metal box L15 W7 H3,5 cm

L Aggancio da definire (L)
 Hooks to be defined (L)

* Altre finiture e colori su richiesta - Other finishes and colors on request - see pag. 136 -137 *
 * Specifiche agganci - Info on hooks pag. 134 - 135 *

Agganci-Hooks

Per le dimensioni dei rosoni e altre specifiche non esitate a contattarci. Se non diversamente richiesto dal cliente, i nostri prodotti vengono forniti con aggancio altezza 150 cm per le tipologie A-D-E-F; con aggancio altezza 70 cm per tipologia B; con aggancio altezza 100 cm per tipologia C; con aggancio altezza 110 cm per tipologia G.

For ceiling cup sizes and other specifications don't hesitate to contact us. Unless otherwise requested by the customer, our products are supplied with 150 cm height hook for types A-D-E-F; with 70 cm height hook for type B; with 100 cm height hook for type C; with 110 cm height hook for type G.

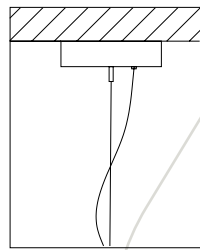

Altezza - Height
MIN 18 cm - 7.08"

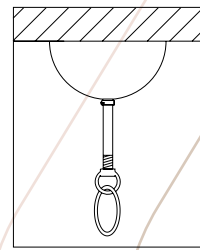

Altezza - Height
MIN 24 cm - 9.44"

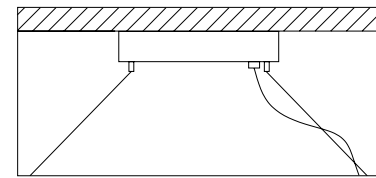

Altezza - Height
MIN 24 cm - 9.44"

A Aggancio con tirante in metallo (A)
Hook with metal cable (A)

L'altezza dei lampadari è calcolata escludendo l'aggancio. Aggancio con rosone o scatola e filo tirante.
The height of the chandeliers is calculated by excluding the hook. Hook with the ceiling cup or metal box and cable.

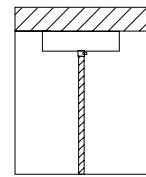

Altezza - Height
MIN 24 cm - 9.44"

D Aggancio con cavo di alimentazione (D)
Hook with power cord (D)

L'altezza dei lampadari è calcolata escludendo l'aggancio. Aggancio con rosone o scatola a soffitto e cavo di alimentazione.
The height of the chandeliers is calculated by excluding the hook. Hook with the ceiling cup and power cord.

B Aggancio con catena (B)
Hook with chain (B)

L'altezza dei lampadari è calcolata escludendo l'aggancio. Aggancio con rosone e catena.
The height of the chandeliers is calculated by excluding the hook. Hook with the ceiling cup and chain.

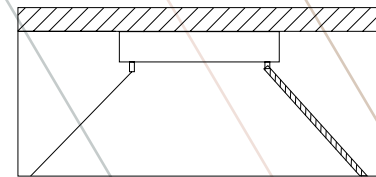

Altezza - Height
MIN 24 cm - 9.44"

E Aggancio con tirante e cavo di alimentazione per sospensioni (E)
Hook with metal cables and power cord for suspension (E)

L'altezza delle sospensioni è calcolata escludendo l'aggancio. Aggancio con rosone, tirante e cavo di alimentazione.
The height of suspensions is calculated by excluding the hook. Hook with the ceiling cup, metal cable and power cord.

C Aggancio con tiranti per sospensioni (C) -
Hook with metal cables for suspension (C)

L'altezza delle sospensioni è calcolata escludendo l'aggancio. Aggancio con rosone o scatola e tiranti.
The height of suspensions is calculated by excluding the hook. Hook with the ceiling cup or metal box and metal cables.

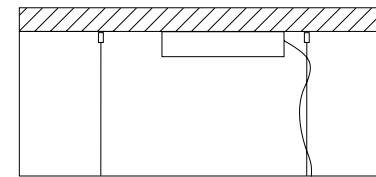

Altezza - Height
MIN 24 cm - 9.44"

F Aggancio con tiranti e tasselli a soffitto (F)
- Hook with metal cables and ceiling cable gripper (F)

L'altezza delle sospensioni è calcolata escludendo l'aggancio. Aggancio con rosone e tiranti con tasselli a soffitto.
The height of suspensions is calculated by excluding the hook. Hook with the ceiling cup and metal cables with ceiling cable gripper.

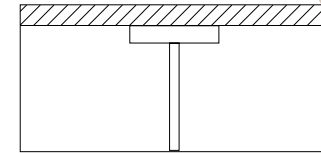

Altezza - Height
MIN 15 cm - 5.91"

G Aggancio altezza fissa (G)
Hook with fixed height (G)

L'altezza delle sospensioni è calcolata escludendo l'aggancio. Aggancio con rosone e aste cilindriche fisse.
The height of the suspension is calculated excluding the hook. Hook with ceiling cup and cylindrical rods.

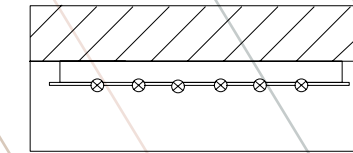

Altezza - Height
MIN 7 cm - 2.75"

H Aggancio con scatola in metallo con luci (H)
Hook with metallic box with lights (H)

L'altezza dei lampadari è calcolata escludendo l'aggancio. Aggancio con scatola in metallo a soffitto ancorata con staffa. Sulla scatola sono posizionate le luci per illuminare la sospensione.
The height of the chandeliers is calculated by excluding the hook. Hook with the metal box and the bracket. On the metal box there are the lights to illuminate the suspension.

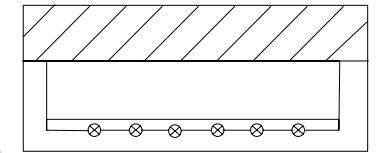

Altezza - Height
MIN 15 cm - 5.90"

I Aggancio con scatola in legno con luci (I)
Hook with wooden box with lights (I)

L'altezza dei lampadari è calcolata escludendo l'aggancio. Aggancio con scatola in legno a soffitto. Sulla scatola sono posizionate le luci per illuminare la sospensione.
The height of the chandeliers is calculated by excluding the hook. Hook with the wooden box. On the wooden box there are the lights to illuminate the suspension.

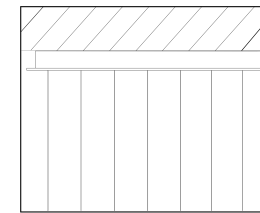

L1

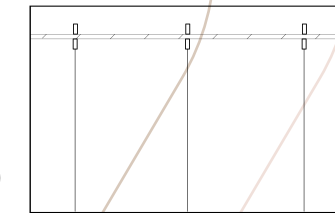



L2

L Aggancio da definire (L) - Hooks to be defined (L)











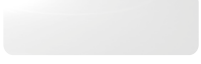







*L'altezza dei lampadari e il relativo prezzo è calcolata escludendo l'aggancio. Per le proposte progettuali è possibile richiedere Aggancio L1: scatola in metallo H MIN 5 cm o in legno H MIN 10 cm, decorati o successivamente verniciabili da ancorare al soffitto con staffa. Aggancio L2: senza scatola; gli elementi prevedono agganci singoli a soffitto. Si richiede la presenza di soffitto in cartongesso.
*The height of the chandeliers and their price is calculated excluding the hook. For project proposals it is possible to request Hook L1: metal box H MIN 5 cm or wood H MIN 10 cm, decorated or subsequently paintable to be anchored to the ceiling with bracket. Hook L2: without box; the elements provide individual ceiling hooks. It requires the presence of plasterboard ceiling.

*** per informazioni specifiche riferirsi alle sezioni relative ai singoli prodotti.
* for specific information refer to individual product sections.**

Finiture metalli - Metal Finishes

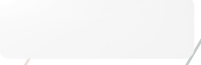

| | | | |
|---|---|--|--|
|  Cromo lucido - Shiny chrome |  Cromo satinato - Satin chrome |  Oro lucido - Shiny gold |  Oro satinato - Satin gold |
|  Nichel nero - Black nickel |  Marrone stagno opaco - Matt tin brown |  VERNICIATO Brunito antico spazzolato - PAINTED Burnished antique brushed | |
|  VERNICIATO oro champagne - PAINTED champagne gold |  VERNICIATO oro satinato - PAINTED satin gold |  VERNICIATO bronzo rosso - PAINTED red bronze |  VERNICIATO Rame - PAINTED Copper |
| |  RAL 9005 nero opaco - opaque black |  RAL 9010 bianco - white |  RAL 2010 Arancio segnale - Signal orange |
|  RAL 3012 Rosso beige - Beige red |  RAL 5021 Ottanio liquido - Teal Blue |  RAL 8238 Blu metallizzato - Metallic Blue |  RAL 6003 Verde Oliva - Olive green |
|  RAL 8011 Marrone metallizzato - Metallic brown |  RAL 441 cedro - lime green |  RAL 1019 Beige grigiastro - Grey beige | |

Finiture vetri - Glass Finishes

| | | | |
|--|---|--|--|
|  Trasparente - Transparent |  Trasparente satinato - Satin transparent |  Fumè grigio - Grey fumè |  Fumè satinato - Satin fumè |
|  Verde diamond - Diamond green |  Rosaline |  Acquamarina - Aquamarine |  Acquamarina satinato - Satin aquamarine |
|  Ambra - Amber |  Topazio - Topaz |  Viridian |  Viridian satinato - Satin viridian |
|  Tabacco - Tobacco |  Tabacco satinato - Satin tobacco |  Ottanio - Teal blue |  Ottanio satinato - Satin teal blue |
|  Marrone satinato - Satin brown |  Violet |  Bianco opalino - Opaline white | |

Finiture vetro metallizzate

- Metallised glass finishes

| | |
|--|---|
|  Nichel nero metallizzato - Metallic black nickel |  Oro lucido metallizzato - Metallic shiny gold |
|--|---|

Euroluce Lampadari non risponde per eventuali danni a persone o cose causati da una non corretta installazione dei propri apparecchi di illuminazione, da un uso di lampadine non conformi e dalla modificazione delle caratteristiche tecnico costruttive.

Il marchio CE è un marchio europeo di garanzia che certifica la qualità del prodotto e la sua rispondenza ai parametri di sicurezza previsti dalle normative CEE.

Euroluce Lampadari può fornire per la quasi totalità dei suoi articoli la certificazione con marchio UL. Questo catalogo è tutelato dalla legge sui diritti d'autore (legge 22/4/1941 n°633 e dalla legge 14/12/1942 n°1485). È vietata ogni riproduzione anche parziale dello stesso.

Euroluce Lampadari is not liable for incidental injuries or damage to people or things due to: incorrect installation of the fixtures, use of not suitable bulbs, modification of the original technical features of the items.

The label CE is a European guaranteed mark. It certifies product quality and its compliance with the safety standards stated by EEC regulations.

Euroluce Lampadari can provide for most of its products the UL certification.

This catalogue is copyrighted and protected by the Italian law (22/4/1941 n°633 and 14/12/1942 n°1485). Any reproduction of this catalogue is strictly forbidden.

Le capacità delle tecniche di stampa non permettono una riproduzione assolutamente fedele delle variazioni cromatiche. Pertanto, si prega di considerare le tonalità di colore come indicazioni approssimative.

Allo stesso modo, le illustrazioni e le descrizioni fornite sono da interpretare in modo approssimativo.

L'azienda si riserva il diritto di apportare modifiche in qualsiasi momento, senza preavviso, al fine di soddisfare le esigenze legate alla produzione e al mercato.

-

The capabilities of printing techniques do not allow for an absolutely faithful reproduction of color variations. Therefore, please consider the color tones as approximate indications. Similarly, the provided illustrations and descriptions should be interpreted in an approximate manner. The company reserves the right to make changes at any time, without prior notice, in order to meet the requirements related to production and the market.

LUMEN

Flusso luminoso nominale. L'indicazione si riferisce al valore in assenza di rifrazione, come dichiarato dal produttore del componente.

Nominal luminous flux. It refers to the value without any refraction, as declared by the component manufacturer.

euroluce

— LIGHT OF ITALY —

ART DIRECTION / STYLING

Studio in Project

PHOTO

Francesco Stragapede

